



Johnson Suisse
Bathroom Solutions

PRICELIST
2024

JohnsonSuisse

Johnson Suisse is a subsidiary of Roca Group world's leading bathroom industry, and is supported by a network of 76 factories in over 170 markets. A multinational corporation with manufacturing capabilities and design centres around the world allow product design to meet the standards and requirement of the Australian market, backed by local teams to provide support and services with the only 25 years' VC warranty in the industry.

Roca Group Manufacturing

Complete Bathroom Solution

Local Australian Team

Global Design Centers



TERMS AND CONDITIONS FOR SALE OF BPA PRODUCTS

Terms and conditions for sale of BPA products

1 Definitions

Agreement means the agreement between BPA and the Buyer in relation to the sale of Goods on these Terms, and any terms specified in any Order accepted by BPA in accordance with these Terms.

Business Day means Monday to Friday, excluding gazetted public holidays in NSW.

Buyer means the buyer of the Goods specified in the Order.

BPA means Bathroom Products Australia Pty Ltd ABN 87 079 297 617 and/or where the context requires, any of its related corporations and where applicable their successors and assigns.

BPA Price List means the official list of Prices published by BPA from time to time online and/or in hard copy form.

Delivery means the physical delivery of the Goods to the Buyer or to the agent of the Buyer.

Delivery Schedule means the written schedule accompanying the Goods on Delivery, setting out a general description and quantity of the Goods, the Order number, the Delivery address, the date and other terms relevant to the Delivery.

Dispatch means dispatch of the Goods from BPA's premises for the purpose of Delivery of the Goods.

Good/s means the product/s specified in an Order.

Inspection Period in relation to certain Goods means 10 Business Days after Delivery of those Goods.

Loss includes, but is not limited to, costs (including legal costs on an indemnity basis), expenses, lost profits, award of damages, personal injury and property damage.

Order means a written request by the Buyer to purchase specified products from BPA.

Price in relation to a Good means the price specified in the then current BPA Price List or, if applicable, in a Quote.

Quote means a written description of the Goods to be provided, the price of those Goods and an estimate of the date of Delivery.

these Terms means the terms and conditions set out in this document as may be varied in accordance with those terms and conditions.

2 Sole agreement

(a) The acceptance of an Order by BPA gives rise to an agreement by BPA and the Buyer that these Terms set out the sole basis for the sale of Goods the subject of that Order to the exclusion of any conditions of sale appearing on any other document of BPA or the Buyer.

(b) Subject to clause 2(c) BPA may vary these Terms at any time by uploading the amended version of these Terms as amended to its website.

(c) Modification of these Terms expressed in any document of a party after the date of acceptance of an Order does not apply to that Order unless expressly agreed to in writing by the other party.

3 Agreement to buy and sell

In return for payment by the Buyer to BPA of the Price of each of the Goods, BPA sells, and the Buyer buys, the Goods on these Terms.

4 Quotes

(a) BPA may provide the Buyer with a Quote. Any Quote issued by BPA is valid for the period specified on the Quote. A Quote does not constitute an offer capable of legally binding acceptance.

(b) Unless otherwise expressly specified in writing, a Quote is subject to the terms and conditions in the Delivery Schedule.

(c) Following provision of a Quote to the Buyer, BPA is not obliged to prepare to supply any Goods until the Quote has been accepted by the Buyer. This occurs by the Buyer sending an Order to BPA.

(d) BPA reserves the right to amend any Quote before the Order has been accepted to take into account any rise or fall in the cost of completing the Order. BPA will notify the Buyer of any amendment as soon as practicable, at which point the amended Quote will be the estimate or Quote under these Terms.

(e) An indication in a Quote of the time of Delivery of the Goods is an estimate only. Subject to any obligations in respect of consumer guarantees under the Australian Consumer Law (Schedule 2 of the Competition and Consumer Act 2010 (Cth) (ACL), this estimate is not binding upon BPA.

5 Placement of Orders

(a) The Buyer must order Goods from BPA by filling out and sending to BPA an Order.

(b) Each Order must specify:

(i) the date of the placement of the Order;

(ii) a unique purchase order number;

(iii) the quantity and description of the Goods ordered;

(iv) the Price according to the relevant Quote or if there is no Quote then BPA's then current Price for each of the Goods;

(v) the address of the Buyer's business premises (to which the Goods will be Delivered); and

(vi) if the Buyer has a preferred date of Delivery - then the preferred Delivery date.

(c) Any terms included by or on behalf of the Buyer in an Order are not binding on BPA and do not form part of the Agreement unless expressly and specifically accepted in writing by an authorised officer of BPA.

6 Acceptance of Orders

(a) BPA may decline any Order received from the Buyer by written notice to the Buyer and will be deemed to have accepted the Order if it has not given such notice within 5 Business Days after the day of receipt of the Order by BPA.

(b) If the Buyer has nominated a preferred Delivery date, then BPA will use reasonable endeavours to advise the Buyer within 7 days of receiving the Order whether or not it can deliver the Goods by the preferred Delivery date. If it advises that it cannot, then the Parties will negotiate in good faith an alternative Delivery date. The Delivery date is not an essential term of the Agreement and BPA will not be liable in damages or otherwise if Delivery does not occur by the preferred Delivery date.

7 Delivery of Orders

(a) BPA agrees to use reasonable endeavours to deliver Goods to the Buyer's business premises specified in the Order between the hours of 9 am and 5 pm on any Business Day. BPA does not deliver to the end-user's site.

(b) BPA will arrange Delivery of the Goods in accordance with BPA's Delivery Schedule.

8 Alterations

(a) The Buyer may prior to Dispatch request that its Order be varied by providing a request in writing to BPA. A request for a variation must be agreed to in writing by BPA in order to have effect.

(b) If the Buyer wishes to vary its requirements after a Quote has been prepared by BPA or after the placement of an Order, BPA reserves the right to vary the Quote to include any Additional Charge in respect of any extra costs incurred or additional services provided due to the variation, in accordance with its then current charge rates.

TERMS AND CONDITIONS FOR SALE OF BPA PRODUCTS

A revised Quote issued by BPA in respect of the requested variation supersedes the original Quote. If the revised Quote only specifies additional work, the Quote for that additional work will be in addition to the immediately preceding Quote for the Goods.

(c) BPA has an automatic extension of time for the provision of the Goods equal to the delay caused by the variation.

(d) Where an Order is cancelled, the Buyer indemnifies BPA against any Losses incurred as a result of the cancellation. This includes, but is not limited to, loss of profit from other orders foregone as a result of the scheduling of the Order which is subsequently cancelled.

9 Additional Charges

(a) BPA may require the Buyer to pay additional charges in respect of costs incurred by BPA as a result of reliance on inadequate or incorrect information or material provided by the Buyer or information or material supplied later than required by BPA in order for it to provide the Goods within the specified time frame (if any).

(b) The imposition of additional charges may also occur as a result of:

(i) cancellation by the Buyer of an Order where cancellation results in Loss to BPA. A minimum restocking fee of 20% of the Price is payable by the Buyer unless otherwise agreed by BPA in writing. The parties agree this is a genuine estimate of BPA's costs;

(ii) storage costs for Goods not collected from BPA within 2 weeks of the date on which the Goods are manufactured, fabricated, created, formed or packed for Dispatch;

(iii) photocopying, courier, packing or handling charges not included in the Quote;

(iv) Government or council taxes or charges not included in the Quote;

(v) call out fee and costs of consultants to inspect and verify alleged defects or damage, where it transpires that BPA is not liable for those defects or damage; or

(vi) additional services of BPA required by the Buyer or any other occurrence which causes BPA to incur costs in respect of the Buyer's Order additional to the quoted cost.

10 Price and Invoicing

(a) An Order is placed on a firm price basis in accordance with the applicable Prices.

(b) BPA will ordinarily invoice the Goods within 7 days of acceptance of the Order. BPA may issue more than one invoice in respect of an Order depending upon the availability of Goods the subject of the invoice.

11 Payment

(a) Unless stated otherwise, the Price is exclusive of GST. The Buyer must pay the Price, plus the requisite GST, in relation to each Order to BPA by electronic funds transfer quoting their debtor code and/or the invoice number:

(i) if no credit arrangement has been previously agreed by BPA in writing, then before Dispatch, and

(ii) otherwise within 30 days from the end of the month in which Delivery occurs

in each case (Payment Due Date).

(b) The Buyer must pay interest on any outstanding amount not paid by Payment Due Date at a rate equal to 5% above the RBA Cash Target Rate last published as at the date of the Order. Interest will accrue daily on the outstanding balance from time to time from the Payment Due Date until the outstanding amount is paid in full.

(c) If payment is not made by the Payment Due Date, then on demand by BPA, the Buyer must at its sole cost return the Goods to BPA. The Goods must be in saleable condition in original packaging.

(d) The Buyer must pay all expenses incurred by BPA in seeking to recover amounts not paid to it by the Payment Due Date, including collection agency fees, and legal costs and disbursements on an indemnity basis.

(e) The Buyer must pay all expenses and Losses (including consequential losses) incurred by BPA in seeking to retake possession of the Goods.

12 Passing of title

Title to the Goods the subject of an Order passes to the Buyer free of encumbrances and all other adverse interests only upon receipt by BPA of payment in full of the Price and GST. Until title to the Goods the subject of an Order passes to the Buyer, BPA holds a security interest in the Goods and all proceeds from the sale of the Goods as contemplated under the Personal Property Securities Act 2009 (Cth) (PPSA).

13 Rights in relation to Goods

(a) BPA reserves the following rights in relation to the Goods in respect of an Order until all amounts owed by the Buyer to BPA in respect of that Order are fully paid:

(i) ownership of the legal and equitable title to the Goods;

(ii) the right to enter the Buyer's premises (or the premises of any associated company or agent where the Goods are located) without liability for trespass or any resulting damage and retake possession of the Goods. In this regard the Buyer agrees to keep the Goods separate from other materials and readily identifiable, until payment in full is made; and

(iii) subject to, and in accordance with, the PPSA, the right to keep or resell any Goods repossessed pursuant to paragraph 13(a)(ii) above.

(b) If the Buyer resells the Goods or products incorporating the Goods, before all moneys payable by the Buyer have been paid to BPA, the Buyer must hold part of the proceeds of any such sale, as represents the invoice price of the Goods sold or incorporated in the products sold, on trust in a separate identifiable account as the beneficial property of BPA. The Buyer must pay this amount to BPA upon demand. Despite these provisions, BPA is entitled to maintain an action against the Buyer for the Price and the risk of the Goods passes to the Buyer upon Dispatch.

(c) Prior to title in the Goods passing to the Buyer under the Agreement, the Buyer agrees that:

(i) the Buyer has no right or claim to any interest in the Goods to secure any liquidated or unliquidated debt or obligation that BPA may owe to the Buyer;

(ii) the Buyer cannot claim any lien over the Goods;

(iii) the Buyer will not create any absolute or defeasible interest in the Goods in relation to any third party except as may be authorised by BPA; and

(iv) where the Buyer is in actual or constructive possession of the Goods:

(A) the Buyer will not deliver them or any document of title to the Goods to any person except as directed by BPA; and

(B) it is in possession of the Goods as a bailee of those Goods and owes BPA the duties and liabilities of a bailee

(v) BPA may take possession of the Goods upon refunding to the Buyer any part payment that may have been made in respect of those Goods.

(d) In connection with the Goods, BPA states to the Buyer that:

(i) BPA has the right to supply the Goods to the Buyer;

(ii) the activities of the Buyer in supplying the Goods do not infringe the rights of the owner of the Goods (where BPA is not the owner of

TERMS AND CONDITIONS FOR SALE OF BPA PRODUCTS

the Goods); and

(iii) if the Goods are not owned by BPA, BPA is authorised to supply the Goods to the Buyer.

(e) BPA and the Buyer agree that pending payment in full for the Goods, the Buyer:

(i) must not supply any of the Goods to any person outside of its ordinary or usual course of business or other than on arms' length market value terms;

(ii) must insure the Goods for their full insurable or replacement value (whichever is the higher) with an insurer licensed or authorised to conduct the business of insurance in the place where the Buyer carries on business; and

(iii) must not remove, deface or obliterate any identifying plate, mark or number on any of the Goods.

14 Passing of risk

Risk in each Order passes to the Buyer upon Delivery of the Goods the subject of that Order to the Buyer or collection of that Order by the Buyer's agent or courier as the case may be, notwithstanding title to the Goods may not have passed to the Buyer.

15 Agency and assignment

(a) The Buyer agrees that BPA may at any time appoint or engage an agent to perform an obligation of BPA arising out of or pursuant to the Agreement.

(b) No agent or distributor of BPA has the authority to legally bind BPA except in accordance with a written notice of authority signed by an authorised office of BPA.

(c) BPA has the right to assign and transfer to any person all or any of its title, estate, interest, benefit, rights, duties and obligations arising in, under or from the Agreement provided that the assignee agrees to assume any duties and obligations of BPA owed to the Buyer under the Agreement.

(d) The Buyer is not to assign, or purport to assign, any of its obligations or rights under the Agreement without the prior written consent of BPA.

16 Term

The Agreement commences on the date it is made and ends when terminated in accordance with any express right of termination set out in the Agreement.

17 Termination

(a) In the absence of any breach of the Agreement, neither party may terminate the Agreement without the written consent of the other party.

(b) The Agreement may be terminated by a party if the other party enters into any composition or arrangement with its creditors or has a receiver appointed over any of its assets or is the subject of any resolution or petition for winding up or judicial management or enters into any form of external administration (other than for the purpose of amalgamation or solvent reconstruction).

(c) Either party may terminate the Agreement if:

(i) the other party is in material breach of any of its obligations under the Agreement; and

(ii) the breach is capable of remedy and fails to remedy the breach for a period of 14 days after receipt of a written notice by the other party requiring rectification of the breach.

(d) Exercise of the right of termination afforded to either party under this clause will not prejudice the legal rights or remedies which either party may have against the other in respect of a breach of any term, condition or warranty of the Agreement.

(e) The obligations of the parties that by their nature could reasonably be construed as being intended to continue to apply beyond the termination of the Agreement will continue to apply.

18 Personal Property Securities Act 2009 (Cth) (PPSA)

(a) The Agreement is a security agreement.

(b) The interest of BPA in the Goods and all proceeds from the sale of the Goods by the Buyer to a third party is a security interest.

(c) The Buyer consents to BPA registering its security interest on the Personal Property Securities Register and agrees to provide all assistance reasonably required by BPA to facilitate registration.

(d) Until title in the Goods has passed to the Buyer as contemplated by clause 12, the Buyer agrees not to in any way assign, charge, lease or otherwise deal with the Goods in such a manner as to create a security interest over the Goods in favour of the Buyer or any third party. The parties agree that this clause will not prohibit the Buyer from selling the Goods in the ordinary course of business.

(e) The Buyer waives its rights to receive any notice under the PPSA (including notice of verification statement) unless the notice is required by that Act and cannot be excluded.

(f) BPA and the Buyer agree that the Agreement and all related information and documents are confidential (Confidential Information) and will not be disclosed to unauthorised representatives or third parties, except to the extent disclosure is permitted by the Agreement or required by law. BPA and the Buyer agree that BPA will not disclose the Confidential Information pursuant to a request under section 275(1) of the PPSA.

(g) Unless otherwise mandated by the PPSA, BPA and the Buyer agree that each of the following requirements or rights under the PPSA does not apply to the enforcement of BPA's security interest in the Goods or of the Agreement:

(i) any requirement for BPA to give the Buyer a notice of removal of accession;

(ii) any requirement for BPA to give the Buyer a notice of BPA's proposed disposal of the Goods;

(iii) any requirement for BPA to include in a statement of account, after disposal of the Goods, the details of any amounts paid to other secured parties;

(iv) any requirement for BPA to give the Buyer a statement of account if BPA does not dispose of the Goods;

(v) any right the Buyer has to redeem the Goods before BPA exercises a right of disposal; and

(vi) any right the Buyer has to reinstate the Agreement before BPA exercises a right of disposal of the Goods.

(h) The Customer must do anything requested by the Company to ensure that its security interest is a perfected security interest and a PMSI and has priority over all other security interests in the goods.

(i) Nothing in this clause 18 is limited by any other provision of these Terms or any other agreement between the parties.

(j) Expressions defined in the PPSA have the same meaning when used in the Agreement.

19 Standard to conform to specifications

(a) Where an Order is for Goods to be bespoke manufactured by BPA for the Buyer according to specifications supplied or approved by or on behalf of, the Buyer, BPA agrees to procure that the Goods are substantially in accordance with and conform to any such specifications, drawings, samples or other description (if any) furnished to BPA or approved by the Buyer.

(b) The Buyer acknowledges and agrees that BPA will not be able to resell bespoke Goods, and that the Price of the Goods together

TERMS AND CONDITIONS FOR SALE OF BPA PRODUCTS

with any other costs reasonably incurred by BPA in designing, manufacturing and/or Delivering the Goods are recoverable by BPA from the Buyer as BPA's loss and damage resulting from the cancellation. The Buyer indemnifies BPA and shall hold it harmless from any Losses suffered or incurred by BPA arising from or in connection with such cancellation.

20 Warranty

The warranty terms set out in the section entitled "Product Warranty" apply to and are incorporated into the Agreement.

21 Inspection and return

(a) All Goods must be inspected by or on behalf of the Buyer within the Inspection Period.

(b) The Buyer must notify BPA in writing of any alleged defects in the Goods and of the Buyer's intention to return the Goods as soon as practicable and in any event within the Inspection Period. The Buyer must hold the Goods believed by it to be defective for BPA's instructions and for a reasonable period not exceeding 14 days after the Buyer gives the said notice.

(c) All returns or claims must be approved by BPA. If approved, BPA will issue a return authorisation number (RAN). The RAN must be included with the returned goods.

(d) The Buyer shall not be entitled to reject or make any claim in relation to any allegedly defective or shortage in quantity of Goods in respect of which it first gives written notice after the Inspection Period in relation to those Goods, unless the defect or shortage was not reasonably ascertainable from an inspection of the Goods that is reasonable having regard to the nature of the Goods and defects or shortage that would be expected may occur in that type of Goods.

(e) Goods must be returned in a saleable condition and in original packaging and the Buyer must pay all freight and other costs of returning the Goods. A restocking fee of 20% of the Price of returned Goods is payable by the Buyer unless BPA otherwise agrees.

(f) The Buyer's obligations under this clause are subject to the Buyer's rights under the ACL which cannot lawfully be contracted out of.

22 Exclusions and limitation of liability

(a) The Buyer expressly agrees that use of the Goods is at the Buyer's risk. To the full extent allowed by law, BPA's liability for breach of any term implied into these Terms by any law is excluded.

(b) All information, specifications and samples provided by BPA in relation to the Goods are approximations only and, subject to any guarantees under the ACL, small deviations or slight variations from them which do not substantially affect the Buyer's use of the Goods will not entitle the Buyer to reject the Goods upon Delivery or to make any claim in respect of them.

(c) Under no circumstances is BPA or any of its suppliers liable or responsible in any way to the Buyer or any other person for any Loss, damages, costs, expenses or other claims (including consequential damages and loss of profits or loss of revenues) as a result, direct or indirect of any defect, deficiency or discrepancy in the Goods, except as expressly provided in the Agreement. This includes their form, content and timeliness of deliveries, failure of performance, error, omission, defect, including, without limitation, for and in relation to any of the following:

- (i) any Goods supplied to the Buyer;
- (ii) any delay in supply of the Goods; or
- (iii) any failure to supply the Goods.

(d) Any advice, recommendation, information, assistance or service given by BPA in relation to Goods, is given in good faith and is believed to be accurate, appropriate and reliable at the time it is given. It is provided without any warranty or accuracy, appropriateness or reliability. BPA does not accept any liability or

responsibility for any Loss suffered as a result of the Buyer's reliance on such advice, recommendation, information, assistance or service.

(e) To the fullest extent permissible at law, BPA is not liable for any direct, indirect, punitive, incidental, special, consequential damages or any damages whatsoever including, without limitation, damages for loss of use, data or profits, arising out of or in any way connected with the provision of or failure to provide Goods, or otherwise arising out of the provision of Goods, whether based on terms of trade, negligence, strict liability or otherwise, even if BPA has been advised of the possibility of damages.

(f) Subject to the ACL, BPA's liability under the Agreement is limited to, at its option:

- (i) replacing the Goods,
- (ii) repairing the Goods,
- (iii) paying the cost of replacing the Goods, or
- (iv) paying the cost of repairing the Goods.

(g) BPA disclaims any liability for lack of operation or performance of Goods where the Goods are used or adapted for a purpose for which they were not designed or integrated with products not manufactured or supplied by BPA.

(h) The ACL may give to the Buyer certain consumer guarantees, which cannot be restricted, limited or varied.

23 Force majeure

(a) If circumstances beyond BPA's control prevent or hinder its provision of the Goods, BPA is free from any obligation to provide the Goods while those circumstances continue. BPA may elect to terminate the Agreement or keep the Agreement on foot but suspended until such circumstances have ceased.

(b) Circumstances beyond BPA's control include, but are not limited to, unavailability of materials or components, strikes, lockouts, riots, natural disasters, fire, war, acts of God, government decrees, proclamations or orders, transport difficulties and failures or malfunctions of computers or other information technology systems.

24 Proper law

The Agreement is governed by the law of the state of New South Wales.

25 Notices

(a) Any notice, approval, consent or other communication under the Agreement must be in writing and in English, may be given by an authorised representative of the sender and delivered personally, or by prepaid registered post, or email, to a party at the address of that party indicated in the Agreement, or to another address as that party may from time to time notify to the other for the purposes of this clause. If two or more people comprise a party, notice to one is effective notice to all.

(b) Proof of posting by prepaid registered post or of dispatch of email will be proof of receipt,

(i) in the case of a letter to an address within the city of dispatch, on the third day after posting, otherwise on the fifth day after posting;

(ii) in the case of an email, provided the recipient acknowledges receipt by return email or other recorded means, at the time such email was received by the recipient as revealed by the recipient's inbox, or otherwise 12 hours after sending unless the sender receives a notice that the email was not delivered;

provided always that that if that time is not between 9am to 5pm on a business day in the place where the recipient is located, service will be deemed to have occurred at 9am on the next business day in that place.

TERMS AND CONDITIONS FOR SALE OF BPA PRODUCTS

26 General

(a) These Terms and any accepted Orders and written variations agreed to in writing by BPA represent the whole agreement between the parties relating to the subject matter of the Agreement.

(b) The Agreement supersedes all oral and written negotiations and communications by and on behalf of either of the parties.

(c) In entering into the Agreement the Buyer has not relied on any warranty, representation or statement, whether oral or written, made by BPA or any of its employees or agents relating to or in connection with the subject matter of the Agreement.

(d) If any provision of the Agreement is rendered void or ineffective by operation of law, the validity or effectiveness of the remainder shall be unaffected.

(e) A party's failure or delay to exercise a power or right does not operate as a waiver of that power or right.

(f) Each party agrees to do anything the other party reasonably asks of it (such as obtaining consents, signing and producing documents and getting documents completed and signed):

(i) to bind the party and its successors under the Agreement;

(ii) to give effect to the intentions of the parties and the objectives of the Agreement and the transactions contemplated by it, including negotiating in good faith with respect to any matters requested by the other party, and by the execution and delivery of documents and other instruments; and

(iii) to use its reasonable endeavours to cause relevant third parties to do likewise to bind every party intended to be bound under the Agreement.

PRODUCT WARRANTY

WARRANTY PERIODS

TOILETS and URINALS

VC Pans, Cisterns, Urinals and Bidets	25 years products replacement (VC only) 1 year parts and labour
---------------------------------------	--

Plastic and In-wall Cisterns	10 years product replacement* 1 year parts and labour *1 year product replacement (commercial)
------------------------------	--

Cistern Valve	3 years product replacement* *1 year product replacement (commercial)
---------------	--

Toilet Seats PP/Urea	5 years product/parts replacement
----------------------	-----------------------------------

Toilet Seats Timber	1 year product/parts replacement
---------------------	----------------------------------

Smart Toilet	25 years product replacement (VC only) 1 year toilet seat replacement 1 year electrical replacement
--------------	---

Urinal Rough-in Electronic Kit	2 years product/parts replacement
--------------------------------	-----------------------------------

TAPWARE and SHOWERS

Tapware	20 years product replacement* 10 years ceramic disc cartridge/aerator/flexi hose 5 years PVD finishes** 1 year non-PVD finishes** 1 year parts and labour * 1 year product replacement (commercial) ** not including normal wear and tear, scratches and damage due to installation or use of abrasive cleaners
---------	---

Electronic Tapware	2 years product replacement 1 year parts for non PVD finishes 5 years parts for PVD finishes 1 year parts and labour
--------------------	---

Showers	20 years product replacement* 1 year parts for non PVD finishes 5 years parts for PVD finishes 1 year parts and labour *Shower hoses, Sliders, Soap Dishes, Wall Fixings and Mounting Brackets: 1 year parts replacement *1 year product replacement (commercial)
---------	---

Spare Parts	5 years replacement product or parts
-------------	--------------------------------------

SHOWER BASES and SCREENS

Shower Bases Polymerable	20 years product replacement New base designs launched from 2020, old base designs hold original warranty periods
--------------------------	--

Shower Tile Trays	10 years product replacement
-------------------	------------------------------

Shower Bases SMC	1 year product replacement
------------------	----------------------------

Shower Screens	10 years product replacement 1 year parts replacement
----------------	--

Shower Wall	5 years product replacement
-------------	-----------------------------

BASINS

VC Basins, Shrouds and Pedestals	25 years products replacement (VC only) 1 year parts and labour
----------------------------------	--

BATHS

Acrylic Baths	15 years product replacement 1 year parts and labour
---------------	---

Steel Baths	10 years product replacement 1 year parts and labour
-------------	---

Bath Components	1 year parts and labour
-----------------	-------------------------

ACCESSORIES

Assist Accessories	20 years product replacement 1 year parts for non PVD finishes 5 years parts for PVD finishes 1 year parts & labour
--------------------	--

Bathroom and Shower Accessories	10 years product replacement* 1 year parts for non PVD finishes 5 years parts for PVD finishes 1 year parts and labour *1 year product replacement (commercial)
---------------------------------	---

Bottle Traps, Wastes and Spare Parts	1 year product replacement
--------------------------------------	----------------------------

*Warranty Periods apply to purchases made from April 1st, 2024

PRODUCT WARRANTY

Express warranty

1. The benefits given by the express warranty set out in this document (Warranty) are in addition to any other rights and remedies that you may have under a law in relation to the goods to which the Warranty relates (Goods). The Warranty is given by Bathroom Products Australia Pty Ltd ABN 87 079 297 617 (BPA or us or our)
2. Our goods come with guarantees that cannot be excluded under Australian Consumer Law. You are entitled to a replacement or refund for a major failure and compensation for any other reasonably foreseeable loss or damage. You are also entitled to have the goods repaired or replaced if the goods fail to be of acceptable quality and the failure does not amount to a major failure.
3. This Warranty only applies to the original owner and user of the Goods (you or the Warranty Claimant) and is not transferable.
4. Some BPA products may have a Warranty Period that differs based on whether they are used for residential or commercial purposes. Where terms and conditions for commercial use are different to these of residential use, they have been specifically detailed. 'Commercial' use includes all use types other than for normal domestic residential purposes. As part of BPA's commitment to continuous improvement BPA reserves the right to make changes to its products at any time without giving any prior notification.
5. Subject to the terms of this Warranty, BPA will provide the respective remedy for the respective Goods set out in the Warranty Period tables above that suffer from the requisite defect in materials or workmanship which defect is notified to BPA within the respective period set out in those tables (each a Warranty Period).
6. Each Warranty Period commences from the date of purchase (not installation), or for new buildings, from the date of Delivery to the building site (Handover).

Warranty Claims

7. To make a claim under this Warranty (Claim) you must contact either the merchant from which the Goods were purchased or BPA directly by online form (obtainable from this link: [BPA Warranty claim form](#) or <https://johnsonsuise.com.au/warrantyform> and complete the following details:
 - a) Details of the product type and product code of the Goods.
 - b) A brief description of the product fault (with photographs of the fault).
 - c) Proof of purchase (or certificate for occupancy for new homes) of the Goods including the date of purchase and where the Goods have been installed.
 - d) Details of the licensed plumber who installed the Goods.
 - e) Your contact details and Handover documentation (if relevant).
8. Within a reasonable time of being notified of the Claim by you or by the merchant (as the case may be) and depending on the circumstances BPA will then contact you to arrange to either:
 - a) replace the Goods, or
 - b) repair the Goods, or
 - c) replace and install new goods equivalent to the Goods, or
 - d) request more information, or
 - e) reject the Claim.
9. BPA reserves the right to provide minor components as 'Parts Only' to you.

10. Where the Goods have not been installed, you must return the Goods at your expense to either their point of purchase, or your nearest BPA distribution centre for evaluation. If the Claim is then accepted, BPA will refund the freight cost to you when you give BPA proof of payment of the freight cost. For hygiene reasons, BPA will

not take possession of toilet seats once the packaging had been opened.

Site Calls

11. Where BPA has arranged a site-call, and a Claim is rejected following inspection (often in the case of unlicensed or incorrect installation), the consumer will be charged a callout fee of \$150 + GST, payable to BPA. In a case where BPA had arranged a repair or replacement, based on information received from a customer or merchant, and it was later found that BPA is not liable for the fault as identified on site, BPA will be entitled to recover any costs directly from the customer. BPA reserves the right to charge a service fee, to be payable by the Warranty Claimant. It is the responsibility of the Warranty Claimant to ensure that installed products are easily accessible for BPA to carry out warranty service. BPA will not be responsible for any costs where adequate access to products is not provided.

Warranty Conditions

12. This Warranty does not cover Claims and BPA will be entitled to reject Claims in any of the following circumstances:

- a) Plumbing installations have not been carried out by a licensed plumber.
- b) Installations that are not in compliance with the Australian Plumbing Code (AS3500) and ABCB (PCA) Guidelines.
- c) The goods have been installed by a licensed plumber but not correctly installed.
- d) The goods have been installed correctly by a licensed plumber, but subsequent repairs, modifications and/or adjustments to the goods after installation have not been carried out by a licensed plumber.
- e) Claims in respect of faulty cistern valves and seals - where after-market sanitizing additives have been introduced into the cistern tank rather than the toilet bowl.
- f) Claims in respect of product surfaces - where harsh cleaning or scouring products have been used (rather than mild household detergent and soft, non-abrasive cloths).
- g) Claims in respect defects permitted under AS1976 – Vitreous China used in Sanitary Applications .
- h) Claims where proof of purchase is not provided.

Warranty Limitations

13. To the extent permitted under Australian Consumer Law, BPA's liability is limited in the following circumstances:

- a) BPA is not responsible for any lack of operation or performance of Goods (or loss or damage) where the Goods have been subject to misuse, negligence, accident BPA is not responsible where Goods are used or adapted for a purpose for which they were not designed.
- b) BPA is not responsible for any lack of operation or performance of Goods (or loss or damage) where the Goods are combined or integrated with other Goods not supplied by BPA.
- c) It is the responsibility of the purchaser and/or installer, before installation, to ensure the Goods are correct and free from obvious visible faults or defects.
- d) Breakage of any glass part is not covered by this Warranty. Glass parts broken during Delivery may be replaced at BPA's discretion provided the breakage is promptly reported and evidence of breakage during transit is provided upon receipt of Goods.
- e) Standards or regulations governing sewerage, plumbing, water supply and gas applicable to the location of the particular plumbing installation are not observed. This includes (without limitation) the Australian Standards (AS/NZ 3500.1 Plumbing and Drainage Part 1: Water services) which specify that the main water supply pressure to any new home, extension or renovation must be limited to 500kPa.

PRODUCT WARRANTY

BPA is not responsible for labour and rectification costs incurred in the above circumstances.

14. Any BPA part or product not specifically listed in the above Warranty Period tables has a 1-year Product replacement Warranty Period.

15. Explanation of Warranty Period remedy terms:

a) Parts and labour - this is the Warranty Period during which the cost of removal of the Goods and re-installation of a replacement product equivalent to the Goods, should that be reasonably required, is covered.

b) Product replacement - this is the Warranty Period during which a replacement product equivalent to the Goods will be supplied (note that this will not include removal or installation).

Consequential Damage

16. Except as expressly stated, and to the extent permitted by law, this Warranty does not include any right to be reimbursed or compensated for physical or financial injury, loss, damage, expense, time or inconvenience (whether direct or indirect) or special or consequential losses arising out of the occurrence of a defect in the parts or products or caused by use or installation of the products or damages caused by acts of nature.

17. To the extent permitted by law, BPA will not be liable for any damage to furniture, floor coverings, walls, fixtures or any other consequential loss of any kind caused by any defect in the Goods or their components.

PRODUCT CARE

Vitreous China Appliances

Vitreous china toilets and basins can be cleaned using mild detergent and warm water with a soft sponge. Avoid the use of harsh and abrasive cleaners as these may scratch the glaze surface.

The bowl should be regularly cleaned using a toilet brush and a proprietary bowl cleanser.

Toilet Seats and Plastic Cisterns

These plastic items can be cleaned using mild detergent and warm water with a soft sponge. Do not use abrasive-type cleaners as these will remove the smooth glossy surface of the plastic.

Care should be taken to avoid staining with household cleaners, bleach, solvents, cosmetics and medicines - any spills should be cleaned up immediately to minimise any discoloration or etching effects to the plastic surface.

Minor scratches may be able to be polished out by carefully using auto cutting compound and polish on the plastic surface. This treatment can also be tried to remove the marks left by minor burns.

Do not use in-cistern sanitizers as these can affect the life and performance of the flush valve seals.

Periodically check and tighten seat hinge fixings.

Bathroom Furniture

The best method of maintaining the glossy finish is simply to wipe over with a clean, soft cloth. It is important that no abrasive cleaners or wax-based creams are used as this can result in a build-up of deposits/scratches that will detract from the appearance. Avoid contact with hard, sharp objects. Should scratches occur on gloss lacquered cabinets, fine marks can be removed using a cutting compound normally used for car re-treatment, followed by a car polish and a clean, soft cloth. In case of spilling any chemicals such as hair lacquer, after shave lotion, nail polish and remover, white spirit and insecticides, remove any residual immediately by washing the product.

Steel Baths

Enamelled steel baths can be cleaned using mild detergent and warm water with a soft sponge. If accidental abrasions occur, the surface brilliance can be restored with a silicon-based polish.

Proprietary porcelain enamel cleaners may be used but any residue should be thoroughly rinsed off afterwards.

Acrylic Baths and Shower Walls

Hot water in contact with this product must not exceed 55°C.

The surface of this base will resist surface build-up. However, to preserve its high gloss it may be cleaned with a soft cloth using warm soapy water or household detergent. Avoid all forms of abrasive. If accidental abrasions occur the surface brilliance can be restored by polishing with "Marbletrend Ultra Gloss" or similar silicone-based polish.

Polymarble, SMC & Acrylic Shower Bases

Hot water in contact with this product must not exceed 55°C.

The surface of this base will resist surface build-up. However, to preserve its high glossy finish it may be cleaned with a soft cloth using warm soapy water or household detergent. Avoid all forms of abrasive. If accidental abrasions occur, the surface brilliance can be restored with a silicon-based polish.

Shower Screens

Shower screens are treated with EnduroShield®

easy-to-clean glass surface treatment. Please follow the care instructions affixed to the door panel to ensure that your treatment is long lasting.

After use, the shower should be cleaned with a mild detergent and water. This is particularly important in hard water districts where insoluble lime salts may be deposited and allowed to build up. Abrasive cleaners should not be used.

Care should be taken to avoid contact with strong chemicals such as organic solvents and strippers.

Tapware & Bathroom Accessories

Never use harsh detergents or abrasive cleaners, as these can scratch the surface. Where your tapware/accessories remain dry in use, a soft cloth can be used to remove surface dust. Alternatively, a wipe over with warm soapy water is all that is required to maintain the finish in perfect condition for a lifetime of use. Use of wax based furniture cream should be avoided as these can result in a buildup of deposits, which could affect the appearance.

Spout aerators should be removed and cleaned periodically (the frequency will be determined by the water quality).

JohnsonSuisse

BATHROOM PRODUCTS AUSTRALIA PTY LTD

ABN 87 079 297 617

All sales and product enquiries 1300 717 717

bpa.info@johnsonsuiss.com.au

Head Office / Sydney Showroom
2/97 Banksia Street, Botany NSW 2019

johnsonsuiss.com.au



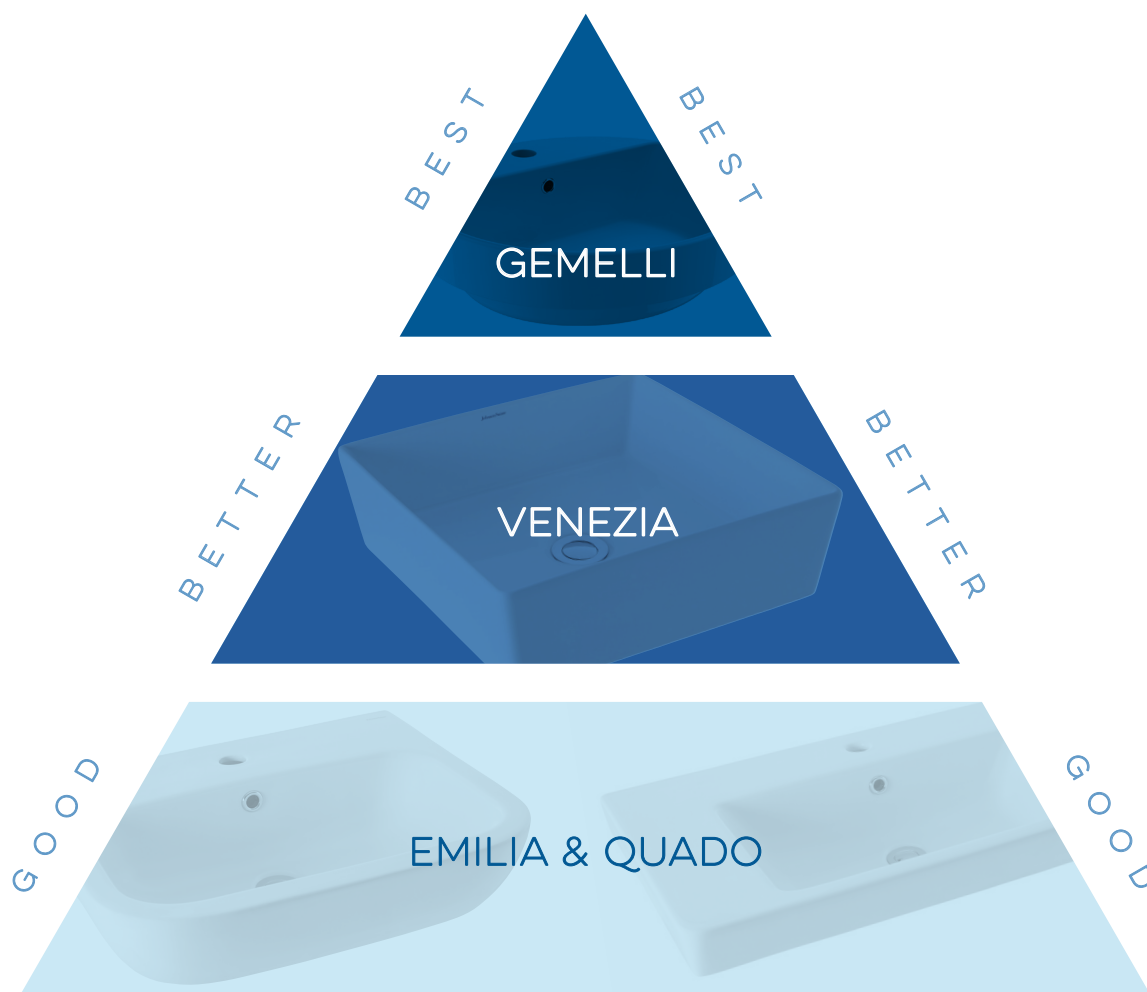

PRODUCT RANGE POSITIONING



VC Replacement 25 year warranty

25 years products replacement for all Vitreous China basins, toilets and urinals.



Titanium technology

An innovative ceramic technology developed to provide bolder, minimalist designs allowing for ultra-thin edges, without having to compromise on product strength or durability.

JohnsonSuisse
Bathroom Solutions

BASINS

Manufactured from high quality vitreous china, Johnson Suisse develops contemporary universal designs without compromising on the functional strength or durability. The exceptional strength and complex designs achievable can be attributed to the Johnson Suisse innovative approach which was applied in creating Titanium technology. This makes it possible to manufacture very thin yet highly durable ceramics, which also come in a range of colour options that suit contemporary Australian bathroom trends. This precise engineering technology is backed up by a 25 year vitreous china warranty.



JohnsonSuisse
Bathroom Solutions

BASIN STYLES



Wall Hung



Semi-Recessed



Vanity
Counter Top



Under Counter



Semi-Inset



Counter Top

COUNTER TOP BASINS



VENEZIA SQUARE 1TH WHITE

Code	RRP (exc. GST)	RRP (inc. GST)
JBSV035.1.PW6	\$244.00	\$268.40

- Modern vitreous china vessel basin with fine lines
- Supplied with Chrome Pop-up Waste 32mm
- Capacity 5.9L
- 1 Taphole
- 135mm above the counter height
- No overflow

Variations

JBSV035.1.PW6B	\$289.00	\$317.90
1 Taphole <u>w</u> Black Pop Up		
JBSV035.1.PW7	\$328.00	\$360.80
1 Taphole <u>w</u> Chrome Pop-Down		

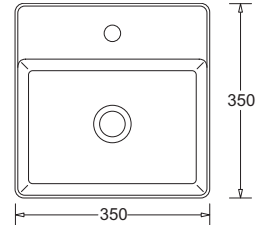

VENEZIA SQUARE 1TH SAND

Code	RRP (exc. GST)	RRP (inc. GST)
JBSV035S.1.PW6	\$317.00	\$348.70

Variations

JBSV035S.1.PW6B	\$361.00	\$397.10
1 Taphole <u>w</u> Black Pop-Up		
JBSV035S.1.PW7	\$399.00	\$438.90
1 Taphole <u>w</u> Chrome Pop-Down		



VENEZIA SQUARE 1TH ASH

Code	RRP (exc. GST)	RRP (inc. GST)
JBSV035A.1.PW6	\$317.00	\$348.70

Variations

JBSV035A.1.PW6B	\$361.00	\$397.10
1 Taphole <u>w</u> Black Pop-Up		
JBSV035A.1.PW7	\$399.00	\$438.90
1 Taphole <u>w</u> Chrome Pop-Down		



VENEZIA SQUARE 1TH MATTE BLACK

Code	RRP (exc. GST)	RRP (inc. GST)
JBSV035MB.1.PW6	\$317.00	\$348.70

Variations

JBSV035MB.1.PW6B	\$361.00	\$397.10
1 Taphole <u>w</u> Black Pop-Up		
JBSV035MB.1.PW7	\$399.00	\$438.90
1 Taphole <u>w</u> Chrome Pop-Down		



COUNTER TOP BASINS



VENEZIA ROUND BOWL WHITE

Code	RRP (exc. GST)	RRP (inc. GST)
JBSV036.PW6	\$244.00	\$268.40

- Features modern vessel style with fine lines
- Benchtap mounting permits wall or bench-top tapware fitting
- Supplied with Chrome Pop-up Waste 32mm
- Capacity 5.2L
- 0 Taphole
- 135mm above the counter height
- No overflow

Variations

JBSV036.PW6B	\$289.00	\$317.90
0 Taphole w Black Pop Up		
JBSV036.PW7	\$328.00	\$360.80
0 Taphole w Chrome Pop-Down		

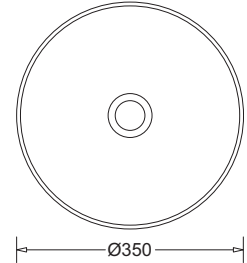

VENEZIA ROUND BOWL SAND

Code	RRP (exc. GST)	RRP (inc. GST)
JBSV036S.PW6	\$317.00	\$348.70

Variations

JBSV036S.PW6B	\$361.00	\$397.10
0 Taphole w Black Pop Up		
JBSV036S.PW7	\$399.00	\$438.90
0 Taphole w Chrome Pop-Down		



VENEZIA ROUND BOWL ASH

Code	RRP (exc. GST)	RRP (inc. GST)
JBSV036A.PW6	\$317.00	\$348.70

Variations

JBSV036A.PW6B	\$361.00	\$397.10
0 Taphole w Black Pop Up 0		
JBSV036A.PW7	\$399.00	\$438.90
0 Taphole w Chrome Pop-Down		



VENEZIA ROUND BOWL MATTE BLACK

Code	RRP (exc. GST)	RRP (inc. GST)
JBSV036MB.PW6	\$317.00	\$348.70

Variations

JBSV036MB.PW6B	\$361.00	\$397.10
0 Taphole w Black Pop Up		
JBSV036MB.PW7	\$399.00	\$438.90
0 Taphole w Chrome Pop-Down		



COUNTER TOP BASINS



VENEZIA SQUARE WHITE

Code	RRP (exc. GST)	RRP (inc. GST)
JBSV038.PW6	\$265.00	\$291.50

- Features modern angular vessel style with fine lines
- Benchtop mounting permits wall or bench-top tapware fitting
- Supplied with Chrome Pop-up Waste 32mm
- Capacity 10.4L
- 0 Taphole
- 120mm above the counter height
- No overflow

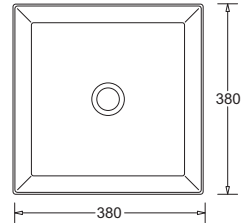

Variations

JBSV038.PW6B	\$308.00	\$338.80
0 Taphole <u>w</u> Black Pop Up		
JBSV038.PW7	\$346.00	\$380.60
0 Taphole <u>w</u> Chrome Pop-Down		

VENEZIA SQUARE SAND

Code	RRP (exc. GST)	RRP (inc. GST)
JBSV038S.PW6	\$342.00	\$376.20

Variations

JBSV038S.PW6B	\$387.00	\$425.70
0 Taphole <u>w</u> Black Pop-Up		
JBSV038S.PW7	\$425.00	\$467.50
0 Taphole <u>w</u> Chrome Pop-Down		



VENEZIA SQUARE ASH

Code	RRP (exc. GST)	RRP (inc. GST)
JBSV038A.PW6	\$342.00	\$376.20

Variations

JBSV038A.PW6B	\$387.00	\$425.70
0 Taphole <u>w</u> Black Pop-Up		
JBSV038A.PW7	\$425.00	\$467.50
0 Taphole <u>w</u> Chrome Pop-Down		



VENEZIA SQUARE MATTE BLACK

Code	RRP (exc. GST)	RRP (inc. GST)
JBSV038MB.PW6	\$342.00	\$376.20

Variations

JBSV038MB.PW6B	\$387.00	\$425.70
0 Taphole <u>w</u> Black Pop-Up		
JBSV038MB.PW7	\$425.00	\$467.50
0 Taphole <u>w</u> Chrome Pop-Down		



COUNTER TOP BASINS



VENEZIA ROUND WHITE

Code	RRP (exc. GST)	RRP (inc. GST)
JBSV039.PW7	\$291.00	\$320.10

- Features modern vessel style with fine lines
- Benchtop mounting permits wall or bench-top tapware fitting
- Pop-down 32mm waste outlet with decorative china cover cap
- Capacity 8.1L
- 0 Taphole
- 130mm above the counter height
- No overflow

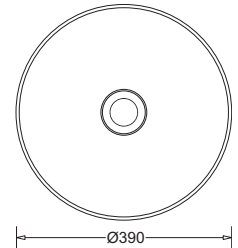

Spare Parts

BL00004BRR	\$33.00	\$36.30
Venezia Waste Disc Cover		

VENEZIA ROUND SAND

Code	RRP (exc. GST)	RRP (inc. GST)
JBSV039S.PW7	\$368.00	\$404.80

Spare Parts

BL00007BTR	\$33.00	\$36.30
Venezia Waste Disc Cover		



VENEZIA ROUND ASH

Code	RRP (exc. GST)	RRP (inc. GST)
JBSV039A.PW7	\$368.00	\$404.80

Spare Parts

BL00005CMR	\$33.00	\$36.30
Venezia Waste Disc Cover		



VENEZIA ROUND MATTE BLACK

Code	RRP (exc. GST)	RRP (inc. GST)
JBSV039MB.PW7	\$368.00	\$404.80

Spare Parts

BL00006PMR	\$33.00	\$36.30
Venezia Waste Disc Cover		



COUNTER TOP BASINS



QUADO COUNTERTOP BASIN 350X350 1TH P/UP

JBSQ035.1.PW6

Features modern vessel style
Wide soap platform area
Capacity 6.6L
1 Taphole
135mm above the counter height
No overflow

RRP (exc. GST)
\$180.00

RRP (inc. GST)
\$198.00

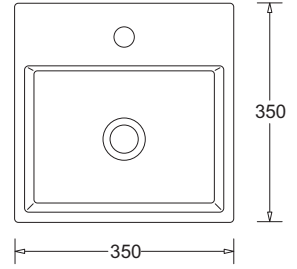

ESTI SQUARE COUNTERTOP BASIN 350x350 0TH P/UP

MBSE035.PW6

Compact square countertop basin
Size 350x350mm
Capacity 9.8L
Height - 135mm above counter
0 Taphole
PW6 32mm Chrome Pop-up waste included

RRP (exc. GST)
\$142.00

RRP (inc. GST)
\$156.20

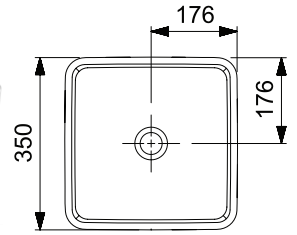

ESTI ROUND COUNTERTOP BASIN 350X350 0TH P/UP

MBSE036.PW6

Compact round countertop basin
350mm diameter size
Capacity 5.3L
Height - 135mm above counter
0 Taphole
PW6 32mm Chrome Pop-up waste included

RRP (exc. GST)
\$142.00

RRP (inc. GST)
\$156.20

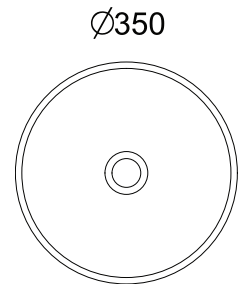

SEMI-INSET BASINS



GEMELLI ROUND SEMI-INSET BASIN 400Ø 0TH P/UP

JBSG640.PW6

RRP (exc. GST)
\$246.00

RRP (inc. GST)
\$270.60

0 Taphole
400mm diameter size
70mm above-counter height
Attractive round style vitreous china vessel
Basin capacity 4.3L
Designed for inset counter top installation

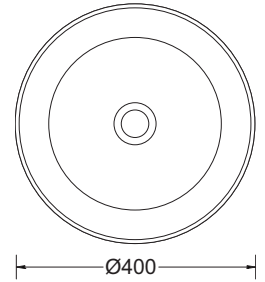

GEMELLI OVAL SEMI-INSET BASIN 450X410 1TH P/UP

JBSG645.1.PW5

RRP (exc. GST)
\$274.00

RRP (inc. GST)
\$301.40

1 Taphole
70mm above-counter height
Attractive oval style vitreous china vessel
Basin capacity 4.9L
Designed for inset counter top installation
Standard overflow

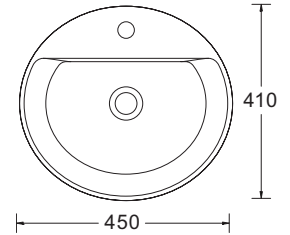

GEMELLI SQUARE SEMI-INSET BASIN 400X400 0TH P/UP

JBSG740.PW1

RRP (exc. GST)
\$274.00

RRP (inc. GST)
\$301.40

70mm above-counter height
Attractive square style vitreous china vessel
Basin capacity 11.5L
Designed for inset counter top installation
No Taphole
Supplied with PW1 Chrome Waste 32mm

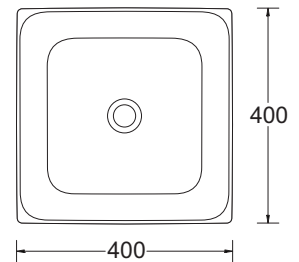

GEMELLI SQUARE SEMI-INSET BASIN 400X400 0TH P/UP

JBSG740.PW6

RRP (exc. GST)
\$274.00

RRP (inc. GST)
\$301.40

70mm above-counter height
Attractive square style vitreous china vessel
Basin capacity 11.5L
Designed for inset counter top installation
No Taphole
Supplied with PW6 Chrome Pop-up Waste 32mm

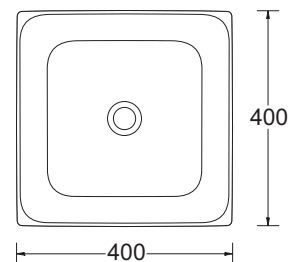

GEMELLI RECTANGLE SEMI-INSET BASIN 450X410 1TH P/UP

JBSG745.1.PW5

RRP (exc. GST)
\$331.00

RRP (inc. GST)
\$364.10

1 Taphole
70mm above-counter height
Attractive rectangular style vitreous china basin
Basin capacity 8.0L
Designed for inset counter top installation
Standard overflow

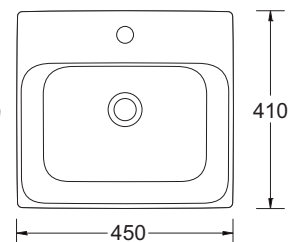

SEMI-INSET BASINS



GEMELLI RECTANGLE SEMI-INSET BASIN 550X410 1TH P/UP

JBSG655.1.PW5

1 Taphole
 70mm above-counter height
 Attractive rectangular style vitreous china basin
 Basin capacity 8.4L
 Standard overflow
 Supplied with PW5 Chrome Pop-up Waste 32mm

RRP (exc. GST) \$331.00
RRP (inc. GST) \$364.10

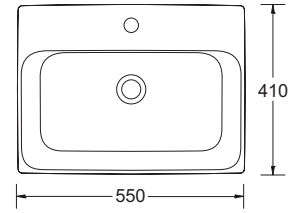

QUADO SEMI INSET BASIN 410X340 1TH P/UP

JBSQ641.1.PW6

1 Taphole
 Wide soap platform area
 45mm above the counter height
 Available with 1 taphole
 Capacity 4.3L
 Contemporary vitreous china semi-inset basin

RRP (exc. GST) \$188.00
RRP (inc. GST) \$206.80

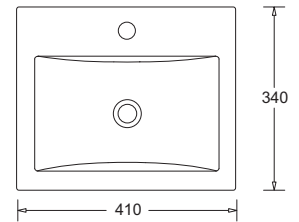

SEMI-RECESSED BASINS



QUADO III SEMI RECESSED BASIN 410X410 1TH CH POP-UP

JBSQ241.1.PW6

RRP (exc. GST)
\$310.00

RRP (inc. GST)
\$341.00

1 Taphole
Wide soap platform area
Capacity 8.8L
Contemporary vitreous china semi-recessed basin
Features modern cubic style
No overflow

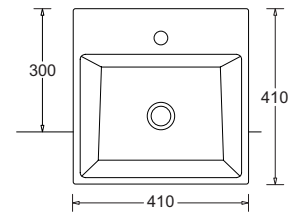

LIFE S/REC BASIN 525X455 1TH P/UP

J3065.1.BT1.PW1

RRP (exc. GST)
\$617.00

RRP (inc. GST)
\$678.70

Medium semi-recessed basin
Size 525x455mm
Capacity 6.4L
1 Taphole, with overflow
Generous soap platform
PW5 32mm Chrome Pop-up waste and Bottle Trap included

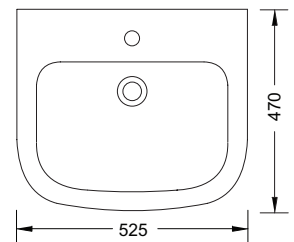

LIFE S/REC BASIN 525X455 1TH P/UP

J3065.1.PW5

RRP (exc. GST)
\$376.00

RRP (inc. GST)
\$413.60

1 Taphole
Capacity 6.4L
Rectangular form contemporary semi-recessed basin. Mid-sized with generous bowl size
Useful flat soap platform area

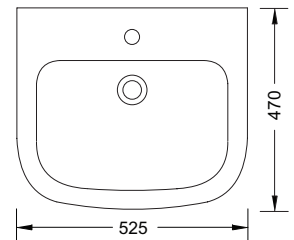

AVON S/REC BASIN 495X420 1TH PLPW

J3010.1.BT1.PW1

RRP (exc. GST)
\$441.00

RRP (inc. GST)
\$485.10

Capacity 4.0L
Suitable for commercial and domestic applications
1 Taphole
Compliant with AS1428.1 Design for Access and Mobility
Mid-sized with generous bowl size
Supplied with PW1 32/40mm Chrome Plug & Waste and Bottle Trap

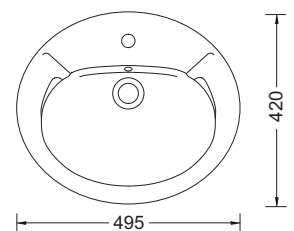

AVON S/REC BASIN 495X420 1TH PLPW

J3010.1.PW2

RRP (exc. GST)
\$199.00

RRP (inc. GST)
\$218.90

Capacity 4.0L
Suitable for commercial and domestic applications
1 Taphole
Compliant with AS1428.1 Design for Access and Mobility
Mid-sized with generous bowl size
Supplied with Chrome O/Flow Plug & Waste 32/40mm

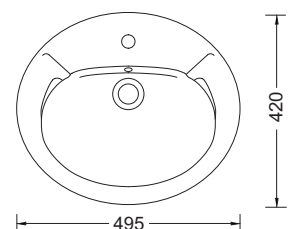

SEMI-RECESSED BASINS



AVON S/REC BASIN 495X420 3TH PLPW

J3010.3.PW2

Capacity 4.0L

Suitable for commercial and domestic applications

3 Taphole

Compliant with AS1428.1 Design for Access and Mobility

Mid-sized with generous bowl size

Supplied with Chrome O/Flow Plug & Waste 32/40mm

RRP (exc. GST)
\$199.00

RRP (inc. GST)
\$218.90

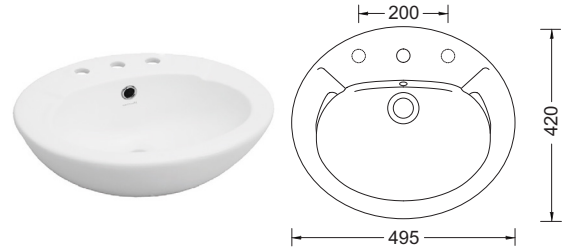

VANITY COUNTER TOP BASINS



EMILIA ROUND VANITY BASIN 360X360 0TH P/UP

JBSE136.PW6

Capacity 4.4L
 Compact space-saving style
 Contemporary vitreous china vanity basin
 No overflow
 No taphole - allows for bench or Wall Mounted-mount tapware
 Supplied with PW6 Chrome Pop-up Waste 32mm

RRP (exc. GST)
 \$161.00

RRP (inc. GST)
 \$177.10

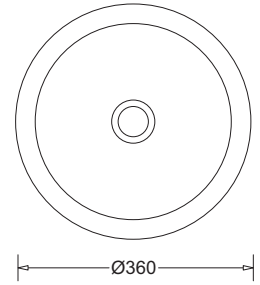

EMILIA RECTANGULAR VANITY BASIN 390X310 0TH P/UP

JBSE139.PW6

Capacity 4.9L
 Compact space-saving style
 Contemporary vitreous china vanity basin
 No overflow
 No taphole - allows for bench or Wall Mounted-mount tapware
 Supplied with PW6 Chrome Pop-up Waste 32mm

RRP (exc. GST)
 \$161.00

RRP (inc. GST)
 \$177.10

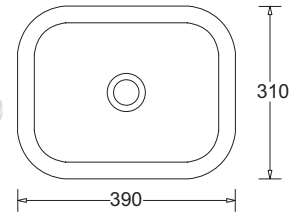

EMILIA OVAL VANITY BASIN 430X310 0TH P/UP

JBSE143.PW6

Capacity 5.0L
 Compact space-saving style
 Contemporary vitreous china vanity basin
 No overflow
 No taphole - allows for bench or Wall Mounted-mount tapware
 Supplied with PW6 Chrome Pop-up Waste 32mm

RRP (exc. GST)
 \$161.00

RRP (inc. GST)
 \$177.10

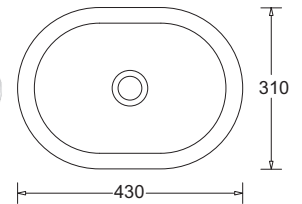

QUADO SQUARE VANITY BASIN 420X420 1TH P/UP

JBSEQ142.1.PW6

1 Taphole
 Capacity 11.4L
 Contemporary vitreous china vanity basin
 Modern squared style
 No overflow
 Supplied with PW6 Chrome Pop-up Waste 32mm

RRP (exc. GST)
 \$208.00

RRP (inc. GST)
 \$228.80

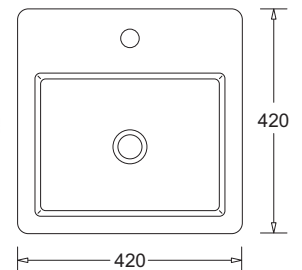

UNDER COUNTER BASINS



EMILIA ROUND UNDER COUNTER BASIN 360X360 0TH P/UP

JBSE236.PW6

360mm diameter
Capacity 7.0L
Contemporary vitreous china vanity basin
No overflow
No taphole - allows for bench or Wall Mounted-mount tapware
Supplied with PW6 Chrome Pop-up Waste 32mm

RRP (exc. GST) \$161.00
RRP (inc. GST) \$177.10

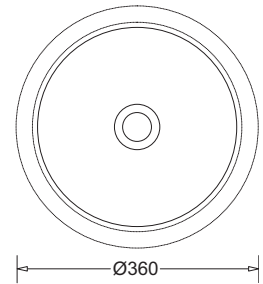

EMILIA SMALL OVAL UNDER COUNTER BASIN 390X300 0TH P/UP

JBSE239.PW6

Capacity 4.2L
Contemporary vitreous china vanity basin
No overflow
No taphole - allows for bench or Wall Mounted-mount tapware
Supplied with PW6 Chrome Pop-up Waste 32mm
Undercounter mounting type

RRP (exc. GST) \$161.00
RRP (inc. GST) \$177.10

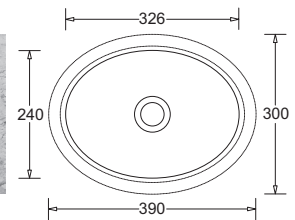

EMILIA RECTANGULAR UNDER COUNTER BASIN 505X370 0TH P/UP

JBSE250.PW6

Capacity 10.4L
Contemporary vitreous china vanity basin
No overflow
No taphole - allows for bench or Wall Mounted-mount tapware
Supplied with PW6 Chrome Pop-up Waste 32mm
Undercounter mounting type

RRP (exc. GST) \$161.00
RRP (inc. GST) \$177.10

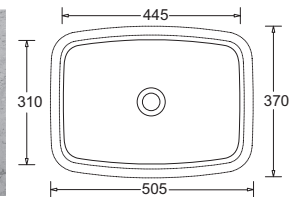

EMILIA LARGE OVAL UNDER COUNTER BASIN 490X330 0TH P/UP

JBSE251.PW6

Capacity 8.5L
Contemporary vitreous china vanity basin
No overflow
No taphole - allows for bench or Wall Mounted-mount tapware
Supplied with PW6 Chrome Pop-up Waste 32mm
Undercounter mounting type

RRP (exc. GST) \$161.00
RRP (inc. GST) \$177.10

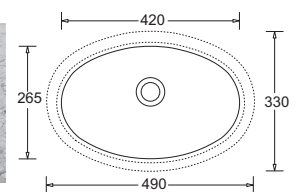

QUADO SQUARE U/C BASIN 475X368 0TH INCL P/UP

J3120.0.PW5

Suitable for commercial and domestic applications
0 Taphole
Capacity 7.5L
Rectangular under counter vanity basin
Supplied with Chrome Pop-up Waste 32mm

RRP (exc. GST) \$241.00
RRP (inc. GST) \$265.10

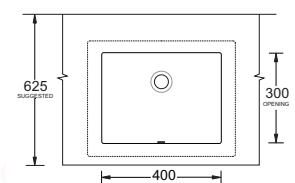

WALL HUNG BASINS



EMILIA 450 WALL BASIN 450X340 1TH P/UP

J3140.1.PW5	RRP (exc. GST) \$267.00	RRP (inc. GST) \$293.70
1 Taphole Capacity 3.5L Small to mid size contemporary standard basin Wide soap platform area Can be converted to 3 Taphole at extra cost Supplied with Chrome Pop-up Waste 32mm		

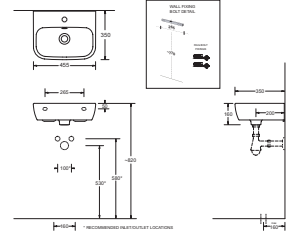

EMILIA 550 WALL BASIN 550X450 1TH P/UP

J3142.1.PW5	RRP (exc. GST) \$308.00	RRP (inc. GST) \$338.80
1 Taphole Capacity 7.2L Contemporary standard basin Matching pedestal and shroud available Wide soap platform area Can be converted to 3 Taphole at extra cost		

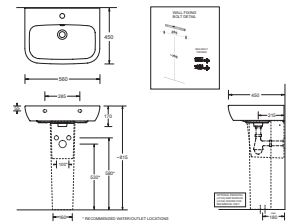

Optional Parts (not included)

Standard Shroud J3168	\$193.00	\$212.30
Standard Pedestal J3149	\$269.00	\$295.90

QUADO 450 WALL BASIN 450X390 0TH CHPW

J3160.0.PW5	RRP (exc. GST) \$250.00	RRP (inc. GST) \$275.00
0 Taphole Capacity 4.0L Contemporary rectangular basin Suitable for commercial and domestic applications Supplied with PW5 Chrome Pop-up Waste 32mm		

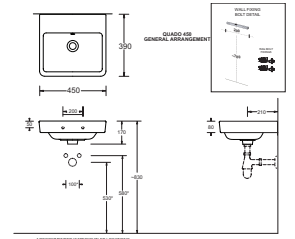

Optional Parts (not included)

Standard Shroud J3168	\$193.00	\$212.30
Standard Pedestal J3149	\$269.00	\$295.90

QUADO 450 WALL BASIN 450X390 1TH P/UP

J3160.1.PW5	RRP (exc. GST) \$250.00	RRP (inc. GST) \$275.00
1 Taphole Capacity 4.0L Contemporary rectangular basin Suitable for commercial and domestic applications Supplied with PW5 Chrome Pop-up Waste 32mm		

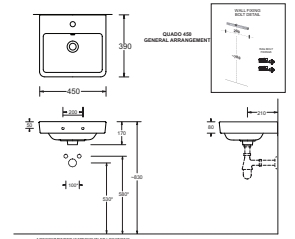

Optional Parts (not included)

Standard Shroud J3168	\$193.00	\$212.30
Standard Pedestal J3149	\$269.00	\$295.90

QUADO 550 WALL BASIN 550X445 1TH P/UP

J3162.1.PW5	RRP (exc. GST) \$290.00	RRP (inc. GST) \$319.00
1 Taphole Capacity 6.6L Matching pedestal and shroud available Mid-sized rectangular basin Supplied with PW5 Chrome Pop-up Waste 32mm		

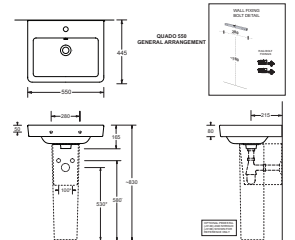

Optional Parts (not included)

Standard Shroud J3168	\$193.00	\$212.30
Standard Pedestal J3149	\$269.00	\$295.90

WALL HUNG BASINS



COLONIAL WALL BASIN 610X455 1TH P/UP

JBSC861.1.PW5

RRP (exc. GST)
\$497.00

RRP (inc. GST)
\$546.70

1 Taphole
Colonial Pedestal (JBSC830) as an optional part (not included).
Bowl capacity 7.1L
Large period style vitreous china washbasin with matching pedestal (JBSC830)
Supplied with PW5 Chrome Pop-up Waste 32mm

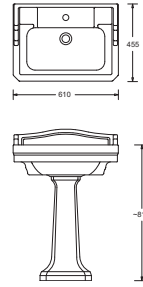

Optional Parts (not included)

Colonial Pedestal JBSC830 \$227.00 \$249.70

COLONIAL WALL BASIN 610X455 3TH P/UP

JBSC861.3.PW5

RRP (exc. GST)
\$497.00

RRP (inc. GST)
\$546.70

3 Taphole
Colonial Pedestal (JBSC830) as an optional part (not included).
Bowl capacity 7.1L
Large period style vitreous china washbasin with matching pedestal (JBSC830)
Supplied with PW5 Chrome Pop-up Waste 32mm

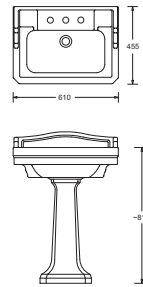

Optional Parts (not included)

Colonial Pedestal JBSC830 \$227.00 \$249.70

COMO WALL BASIN 525X425 1TH PLPW

J3180.1.PW2

RRP (exc. GST)
\$230.00

RRP (inc. GST)
\$253.00

Attractive mid-size standard basin style
Wide soap platform area
Matching shroud available
Capacity 6.5L
Supplied with PW2 Plastic O/Flow Plug & Waste
1 Taphole

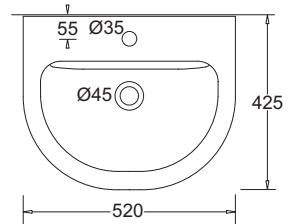

Optional Parts (not included)

Como Shroud (Set) J3187.A \$251.00 \$276.10

MILANO CORNER

MBSM830.1.PW2

RRP (exc. GST)
\$174.00

RRP (inc. GST)
\$191.40

1 Taphole
Capacity 3.9L
Compact hand rinse basin. Suits single mixer style tap
Suitable in installations where space is limited
Supplied with Plastic Overflow Plug and Waste

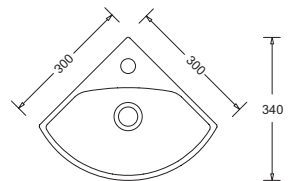

WINDSOR 410 COMPACT

J3190.1.PW2

RRP (exc. GST)
\$230.00

RRP (inc. GST)
\$253.00

1 Taphole
Capacity 2.0L
Compact hand rinse basin. Suits single mixer style tap
Suitable in installations where space is limited
Supplied with Plastic Overflow Plug and Waste

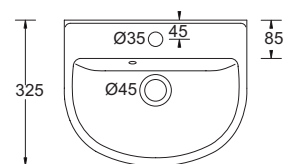

WALL HUNG BASINS



WINDSOR 480 COMPACT

J3192.1.PW2

1 Taphole
Capacity 2.4L
Compact hand rinse basin. Suits single mixer style tap
Suitable in installations where space is limited
Supplied with Plastic Overflow Plug and Waste

RRP (exc. GST) \$230.00
RRP (inc. GST) \$253.00

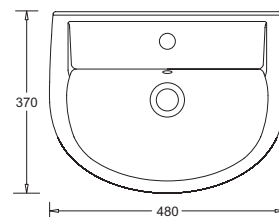

GEMELLI COMPACT WALL BASIN 400X290 1TH P/UP

JBSG840.1.PW6

1 Taphole
Capacity 3.8L
Contemporary vitreous china basin
Generous soap platform
No overflow
Single taphole for mixer tap

RRP (exc. GST) \$239.00
RRP (inc. GST) \$262.90

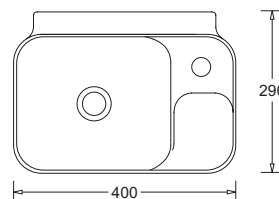

QUADO COMPACT WALL BASIN 400X230 LH 1TH P/UP

JBSQ840L.1.PW6

Bowl capacity 2.9L
Contemporary compact vitreous china Wall Mounted basin
Features a soap platform area
May be Wall Mounted or cabinet mounted
No overflow
1 Taphole

RRP (exc. GST) \$203.00
RRP (inc. GST) \$223.30

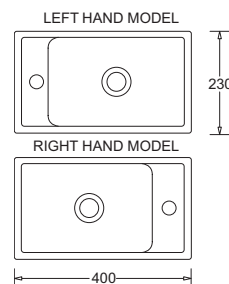

QUADO COMPACT WALL BASIN 400X230 RH 1TH P/UP

JBSQ840R.1.PW6

Bowl capacity 2.9L
Contemporary compact vitreous china Wall Mounted basin
Features a soap platform area
May be Wall Mounted or cabinet mounted
No overflow
1 Taphole

RRP (exc. GST) \$203.00
RRP (inc. GST) \$223.30

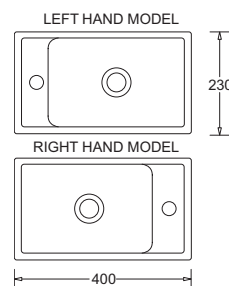

QUADO COMPACT WALL BASIN 400X230 RH 0TH P/UP

JBSQ840R.0.PW6

Bowl capacity 2.9L
Contemporary compact vitreous china Wall Mounted basin
Features a soap platform area
May be Wall Mounted or cabinet mounted
No overflow
No Taphole

RRP (exc. GST) \$203.00
RRP (inc. GST) \$223.30

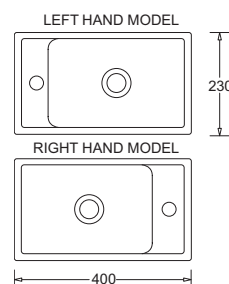

WALL HUNG BASINS



CLASSICA COMPACT WALL BASIN 400X250 1TH P/UP

J3150.1.PW5

1 Taphole RH
Capacity 2.2L
Compact hand rinse basin. Suits single mixer style tap
Suitable in installations where space is limited
Supplied with Chrome O/Flow Plug & Waste 32/40mm

RRP (exc. GST)
\$229.00

RRP (inc. GST)
\$251.90

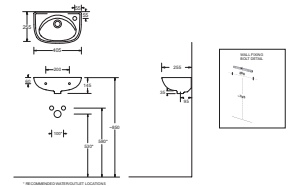

TOLEDO SHELF BASIN 580X450 LH 1TH P/UP

JBST858L.1.PW5

1 Taphole
Bowl capacity 5.5L
Large modern style vitreous china washbasin
May be Wall Mounted mounted in a corner or bench mounted
Standard overflow
Supplied with PW5 Chrome Pop-up Waste 32mm

RRP (exc. GST)
\$253.00

RRP (inc. GST)
\$278.30

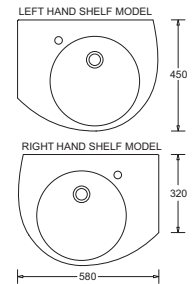

TOLEDO SHELF BASIN 580X450 RH 1TH P/UP

JBST858R.1.PW5

1 Taphole
Bowl capacity 5.5L
Large modern style vitreous china washbasin
May be Wall Mounted mounted in a corner or bench mounted
Standard overflow
Supplied with PW5 Chrome Pop-up Waste 32mm

RRP (exc. GST)
\$253.00

RRP (inc. GST)
\$278.30

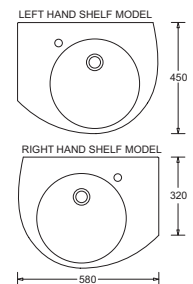

COMMERCIAL BASINS



EMILIA MK II 457X390MM 0TH P/UP

JBSE460.PW6

Medium wall basin
Size 457x390mm
0 Taphole
No overflow
PW6 32mm Chrome Pop-up waste included

RRP (exc. GST)
\$296.00

RRP (inc. GST)
\$325.60

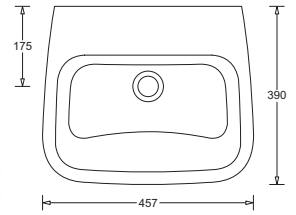

Optional Parts (not included)

Emilia MK II Shroud JBSE461	\$169.00	\$185.90
-----------------------------	----------	----------

LIFE II WALL BASIN 495X410 1TH P/UP

JBSL849.1.PW6

Contemporary vitreous china basin
Wide soap platform area
32mm waste outlet with decorative china cover cap
Capacity 8.3L
1 Taphole
Supplied with PW1 Chrome O/Flow Plug & Waste 32/40mm

RRP (exc. GST)
\$289.00

RRP (inc. GST)
\$317.90

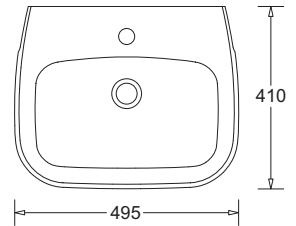

Optional Parts (not included)

Life Shroud JBSL852	\$169.00	\$185.90
---------------------	----------	----------

BOSTON TYPE B MEDIUM CLINICAL STAFF HAND BASIN 610X460 0TH (NO O/F) CHPW

J3092.0.PW1

0 taphole
Durable, hygienic glaze finish
Large D-shaped basin for clinic use
Supplied with PW1 Chrome O/Flow Plug & Waste 32/40mm included

RRP (exc. GST)
\$684.00

RRP (inc. GST)
\$752.40

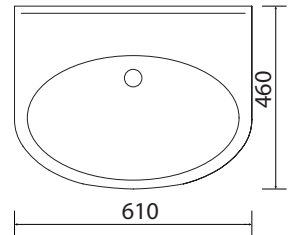

Optional Parts (not included)

Boston Shroud J3189	\$229.00	\$251.90
---------------------	----------	----------

BOSTON TYPE B MEDIUM CLINICAL STAFF HAND BASIN 610X460 1TH (NO O/F) CHPW

J3092.1.PW1

1 taphole
Durable, hygienic glaze finish
Large D-shaped basin for clinic use
Supplied with PW1 Chrome O/Flow Plug & Waste 32/40mm included

RRP (exc. GST)
\$684.00

RRP (inc. GST)
\$752.40

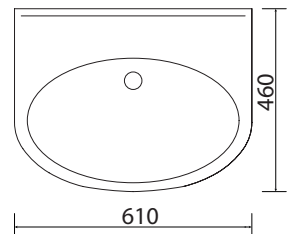

Optional Parts (not included)

Boston Shroud J3189	\$229.00	\$251.90
---------------------	----------	----------

BOSTON TYPE C NON-CLINICAL SMALL/MED STAFF HAND BASIN 500X430 0TH (NO O/F) CHPW

J3094.0.PW1

0 taphole
Chrome O/Flow Plug & Waste 32/40mm included
D-shaped basin for clinic use
Durable, hygienic glaze finish

RRP (exc. GST)
\$470.00

RRP (inc. GST)
\$517.00

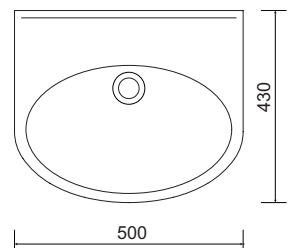

Optional Parts (not included)

Boston Shroud J3189	\$229.00	\$251.90
---------------------	----------	----------

COMMERCIAL BASINS



BOSTON TYPE C NON-CLINICAL SMALL/MED STAFF HAND BASIN 500X430 1TH (NO O/F) CHPW

J3094.1.PW1	RRP (exc. GST) \$470.00	RRP (inc. GST) \$517.00
1 taphole Chrome O/Flow Plug & Waste 32/40mm included D-shaped basin for clinic use Durable, hygienic glaze finish		

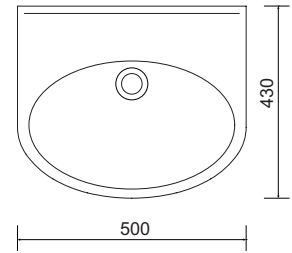

Optional Parts (not included)

Boston Shroud J3189	\$229.00	\$251.90
---------------------	----------	----------

EGG JUNIOR BASIN 500X360 1TH CHPW

C01427.1.PW1	RRP (exc. GST) \$560.00	RRP (inc. GST) \$616.00
Recommended tap Presto 504 Push Button Wall Mounted Mounted Tap - JTP121 Can be Wall Mounted or counter top mounted HYGIENE Glaze nano-technology prevents bacteria build up and improves cleaning time. Matching Egg Junior toilet suites available Supplied with PW1 Chrome O/Flow Plug & Waste 32/40mm Uniquely designed for children		

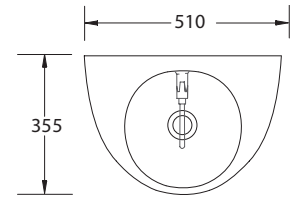

LUCCA SHELF BASIN (LH) 750X470 0TH (NO O/F) W CHPW

J3170L.0.N.PW1	RRP (exc. GST) \$443.00	RRP (inc. GST) \$487.30
0 Taphole Capacity 6.6L Large Wall Mounted basin with wide soap platform area Shelf on left side No overflow Supplied with PW1 Chrome Pop-up Waste 32mm		

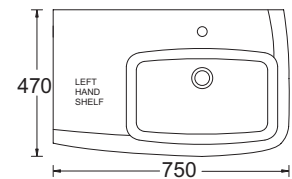

Optional Parts (not included)

Standard Shroud J3168	\$193.00	\$212.30
-----------------------	----------	----------

LUCCA SHELF BASIN (LH) 750X470 0TH CHR POP-UP (NO O/F)

J3170L.0.N.PW6	RRP (exc. GST) \$443.00	RRP (inc. GST) \$487.30
0 Taphole Capacity 6.6L Large Wall Mounted basin with wide soap platform area Shelf on left side No overflow Supplied with PW6 Chrome Pop-up Waste 32mm		

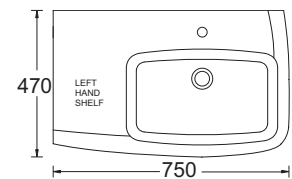

Optional Parts (not included)

Standard Shroud J3168	\$193.00	\$212.30
-----------------------	----------	----------

LUCCA SHELF BASIN (LH) 750X470 1TH INCL JS BOTTLETRAP & CHPW (NO O/F)

J3170L.1.N.BT1.PW1	RRP (exc. GST) \$684.00	RRP (inc. GST) \$752.40
Basin including bottle trap Large Wall Mounted basin with wide soap platform area Capacity 6.6L 1 taphole No overflow Left side shelf		

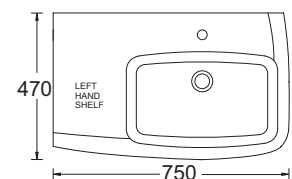

Optional Parts (not included)

Standard Shroud J3168	\$193.00	\$212.30
-----------------------	----------	----------

COMMERCIAL BASINS



LUCCA SHELF BASIN (LH) 750X470 1TH INCL SHROUD & CHPW (NO O/F)

J3170L.1.N.J3168.PW1	RRP (exc. GST)	RRP (inc. GST)
	\$636.00	\$699.60

Basin including shroud
 Large Wall Mounted basin with wide soap platform area
 Capacity 6.6L
 1 taphole
 No overflow
 Left side shelf

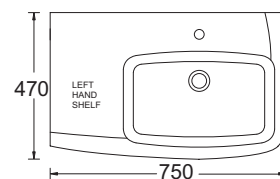

LUCCA SHELF BASIN (LH) 750X470 1TH CHPW (NO O/F)

J3170L.1.N.PW1	RRP (exc. GST)	RRP (inc. GST)
	\$443.00	\$487.30

1 Taphole
 Capacity 6.6L
 Large Wall Mounted basin with wide soap platform area
 Shelf on left side
 No overflow
 Supplied with PW1 Chrome Plug & Waste 32mm

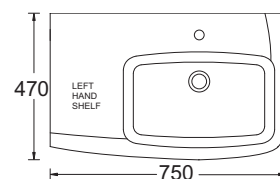

Optional Parts (not included)

Standard Shroud J3168	\$193.00	\$212.30
-----------------------	----------	----------

LUCCA SHELF BASIN (LH) 750X470 1TH CHR POP-UP (NO O/F)

J3170L.1.N.PW6	RRP (exc. GST)	RRP (inc. GST)
	\$443.00	\$487.30

1 Taphole
 Capacity 6.6L
 Large Wall Mounted basin with wide soap platform area
 Shelf on left side
 No overflow
 Supplied with PW6 Chrome Pop-up Waste 32mm

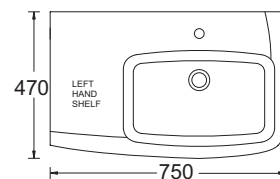

Optional Parts (not included)

Standard Shroud J3168	\$193.00	\$212.30
-----------------------	----------	----------

LUCCA SHELF BASIN (RH) 750X470 0TH (NO O/F) W CHPW

J3170R.0.N.PW1	RRP (exc. GST)	RRP (inc. GST)
	\$443.00	\$487.30

0 Taphole
 Capacity 6.6L
 Large Wall Mounted basin with wide soap platform area
 Shelf on right side
 No overflow
 Supplied with PW1 Chrome Plug & Waste 32mm

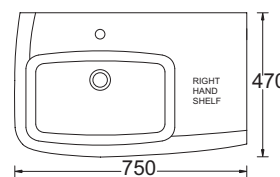

Optional Parts (not included)

Standard Shroud J3168	\$193.00	\$212.30
-----------------------	----------	----------

LUCCA SHELF BASIN (RH) 750X470 0TH CHR POP-UP (NO O/F)

J3170R.0.N.PW6	RRP (exc. GST)	RRP (inc. GST)
	\$443.00	\$487.30

0 Taphole
 Capacity 6.6L
 Large Wall Mounted basin with wide soap platform area
 Shelf on right side
 No overflow
 Supplied with PW6 Chrome Pop-up Waste 32mm

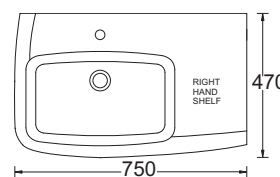

Optional Parts (not included)

Standard Shroud J3168	\$193.00	\$212.30
-----------------------	----------	----------

COMMERCIAL BASINS



LUCCA SHELF BASIN (LH) 750X470 1TH INCL JS BOTTLETRAP & CHPW (NO O/F)

J3170R.1.N.BT1.PW1	RRP (exc. GST)	RRP (inc. GST)
	\$684.00	\$752.40

Basin including bottle trap
 Large Wall Mounted basin with wide soap platform area
 Capacity 6.6L
 1 taphole
 No overflow
 Right side shelf

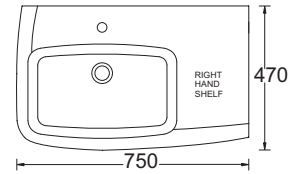

Optional Parts (not included)

Standard Shroud J3168	\$193.00	\$212.30
-----------------------	----------	----------

LUCCA SHELF BASIN (LH) 750X470 1TH INCL SHROUD & CHPW (NO O/F)

J3170R.1.N.J3168.PW1	RRP (exc. GST)	RRP (inc. GST)
	\$636.00	\$699.60

Basin including shroud
 Large Wall Mounted basin with wide soap platform area
 Capacity 6.6L
 1 taphole
 No overflow
 Right side shelf

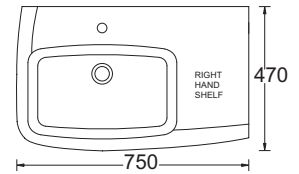

LUCCA SHELF BASIN (RH) 750X470 1TH CHPW (NO O/F)

J3170R.1.N.PW1	RRP (exc. GST)	RRP (inc. GST)
	\$443.00	\$487.30

1 Taphole
 Capacity 6.6L
 Large Wall Mounted basin with wide soap platform area
 Shelf on right side
 No overflow
 Supplied with PW1 Chrome Pop-up Waste 32mm"

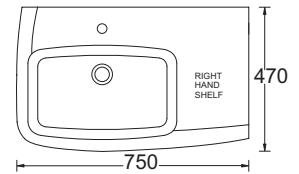

Optional Parts (not included)

Standard Shroud J3168	\$193.00	\$212.30
-----------------------	----------	----------

LUCCA SHELF BASIN (RH) 750X470 1TH CHR POP-UP (NO O/F)

J3170R.1.N.PW6	RRP (exc. GST)	RRP (inc. GST)
	\$443.00	\$487.30

1 Taphole
 Capacity 6.6L
 Large Wall Mounted basin with wide soap platform area
 Shelf on right side
 No overflow
 Supplied with PW6 Chrome Pop-up Waste 32mm

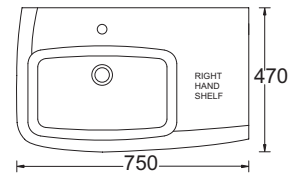

Optional Parts (not included)

Standard Shroud J3168	\$193.00	\$212.30
-----------------------	----------	----------

OPTIONAL PARTS

JS BOTTLETRAP ROUND CHROME 40MM SLIMLINE INCL 32MM ADAPTOR

BT1

RRP (exc. GST) \$234.00
RRP (inc. GST) \$257.40

Chrome Bottle Trap fitting waste outlets suitable for use with all wall & semi recessed basins
40/32mm bottle trap
Chrome finish
Durable brass construction
Fits 40mm and 32mm waste outlets
Vertically and horizontally adjustable

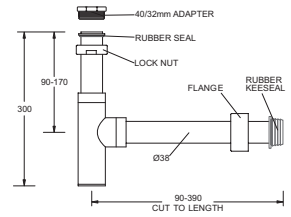

JS BOTTLETRAP ROUND BLACK 40MM SLIMLINE INCL 32MM ADAPTOR

BT1B

RRP (exc. GST) \$272.00
RRP (inc. GST) \$299.20

Black Bottle Trap fitting waste outlets suitable for use with all wall & semi recessed basins
40/32mm bottle trap
Matte black finish
Durable brass construction
Fits 40mm and 32mm waste outlets
Vertically and horizontally adjustable

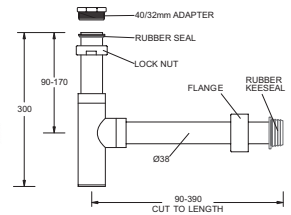
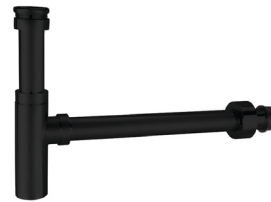

JS VENEZIA BOTTLETRAP 32MM CHROME

BT2

RRP (exc. GST) \$151.00
RRP (inc. GST) \$166.10

32mm bottle trap
Chrome finish
Durable brass construction
Fits 32mm waste outlets
Vertically and horizontally adjustable

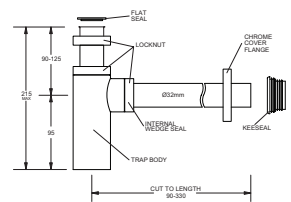

JS VENEZIA BOTTLETRAP 32MM MATTE BLACK

Bt2EMB

RRP (exc. GST) \$188.00
RRP (inc. GST) \$206.80

32mm bottle trap
Matte black finish
Durable brass construction
Fits 32mm waste outlets
Vertically and horizontally adjustable

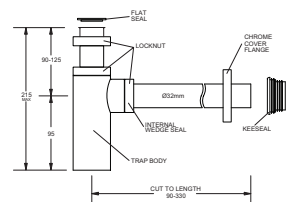

JS VENEZIA BOTTLETRAP 32MM GUN METAL

BT2EGM

RRP (exc. GST) \$219.00
RRP (inc. GST) \$240.90

32mm bottle trap
Gun metal finish
Durable brass construction
Fits 32mm waste outlets
Vertically and horizontally adjustable

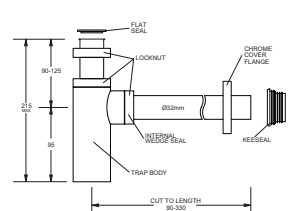

OPTIONAL PARTS

VENEZIA BOTTLETRAP PVD BRUSHED NICKEL

BT2PBN

32mm bottle trap
PVD brushed nickel finish
Durable brass construction
Fits 32mm waste outlets
Vertically and horizontally adjustable

RRP (exc. GST)
\$219.00

RRP (inc. GST)
\$240.90

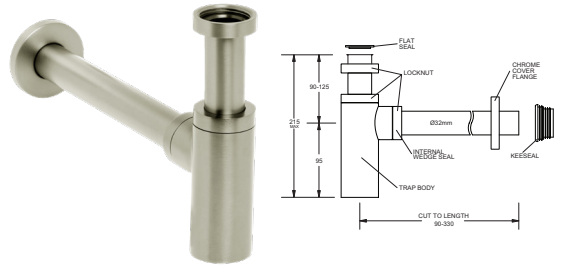

VENEZIA BOTTLETRAP PVD BRUSHED BRASS

BT2PBB

32mm bottle trap
PVD Brushed brass finish
Durable brass construction
Fits 32mm waste outlets
Vertically and horizontally adjustable

RRP (exc. GST)
\$219.00

RRP (inc. GST)
\$240.90

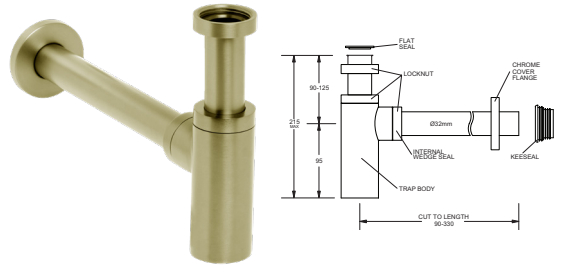

VENEZIA POP-UP WASTE 32MM WITH OVERFLOW CHROME

PW5

32mm Pop-up basin waste with overflow
Chrome finish
Integrated Pop-Up plug with silicone sealing washer
Designed for use with basin fitted with bowl overflows
Durable brass construction

RRP (exc. GST)
\$34.00

RRP (inc. GST)
\$37.40

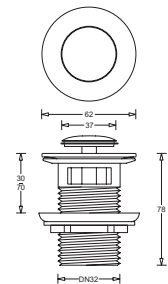

VENEZIA POP-UP WASTE 32MM WITH OVERFLOW MATTE BLACK

PW5EMB

32mm Pop-up basin waste with overflow
Matte black finish
Integrated Pop-Up plug with silicone sealing washer
Designed for use with basin fitted with bowl overflows
Durable brass construction

RRP (exc. GST)
\$62.00

RRP (inc. GST)
\$68.20

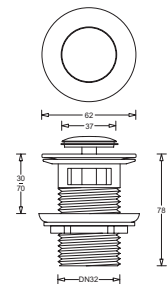

VENEZIA POP-UP WASTE 32MM WITH OVERFLOW GUN METAL

PW5EGM

32mm Pop-up basin waste with overflow
Gun metal finish
Integrated Pop-Up plug with silicone sealing washer
Designed for use with basin fitted with bowl overflows
Durable brass construction

RRP (exc. GST)
\$67.00

RRP (inc. GST)
\$73.70

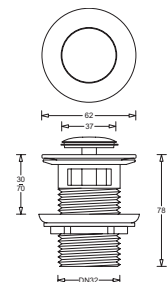

OPTIONAL PARTS

VENEZIA POP-UP WASTE 32MM WITH OVERFLOW PVD BRUSHED NICKEL

PW5PBN

32mm Pop-up basin waste with overflow
 Brushed nickel finish
 Integrated Pop-Up plug with silicone sealing washer
 Designed for use with basin fitted with bowl overflows
 Durable brass construction

RRP (exc. GST) \$67.00
RRP (inc. GST) \$73.70

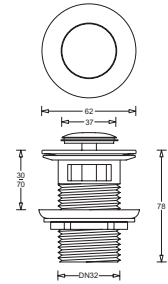

VENEZIA POP-UP WASTE 32MM WITH OVERFLOW PVD BRUSHED BRASS

PW5PBB

32mm Pop-up basin waste with overflow
 Brushed brass finish
 Integrated Pop-Up plug with silicone sealing washer
 Designed for use with basin fitted with bowl overflows
 Durable brass construction

RRP (exc. GST) \$67.00
RRP (inc. GST) \$73.70

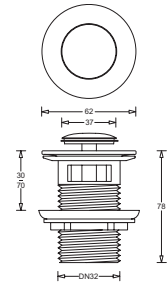

VENEZIA POP-UP WASTE 32MM WITHOUT OVERFLOW CHROME

PW6

32mm Pop-up basin waste without overflow
 Chrome finish
 Integrated Pop-Up plug with silicone sealing washer
 Designed for use with basin with no bowl overflows
 Durable brass construction

RRP (exc. GST) \$34.00
RRP (inc. GST) \$37.40

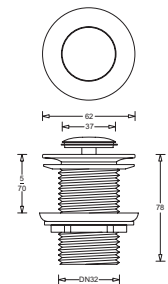

VENEZIA POP-UP WASTE 32MM WITHOUT OVERFLOW MATTE BLACK

PW6EMB

32mm Pop-up basin waste without overflow
 Matte black finish
 Integrated Pop-Up plug with silicone sealing washer
 Designed for use with basin with no bowl overflows
 Durable brass construction

RRP (exc. GST) \$62.00
RRP (inc. GST) \$68.20

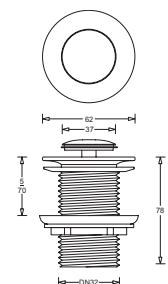

VENEZIA POP-UP WASTE 32MM WITHOUT OVERFLOW GUN METAL

PW6EGM

32mm Pop-up basin waste without overflow
 Gun metal finish
 Integrated Pop-Up plug with silicone sealing washer
 Designed for use with basin with no bowl overflows
 Durable brass construction

RRP (exc. GST) \$67.00
RRP (inc. GST) \$73.70

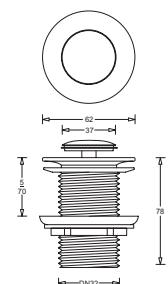

OPTIONAL PARTS

VENEZIA POP-UP WASTE 32MM WITHOUT OVERFLOW GUN METAL

PW6EGM

32mm Pop-up basin waste without overflow
Gun metal finish
Integrated Pop-Up plug with silicone sealing washer
Designed for use with basin with no bowl overflows
Durable brass construction

RRP (exc. GST) \$67.00
RRP (inc. GST) \$73.70

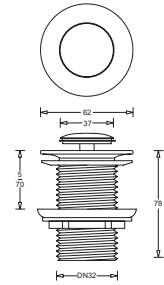
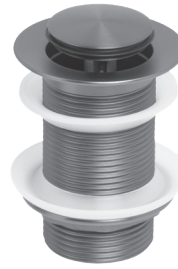

VENEZIA POP-UP WASTE 32MM WITHOUT OVERFLOW PVD BRUSHED NICKEL

PW6PBN

32mm Pop-up basin waste without overflow
Brushed nickel finish
Integrated Pop-Up plug with silicone sealing washer
Designed for use with basin with no bowl overflows
Durable brass construction

RRP (exc. GST) \$67.00
RRP (inc. GST) \$73.70

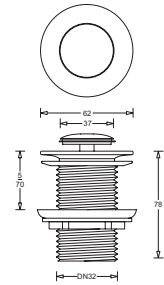

VENEZIA POP-UP WASTE 32MM WITHOUT OVERFLOW PVD BRUSHED BRASS

PW6PBB

32mm Pop-up basin waste without overflow
Brushed brass finish
Integrated Pop-Up plug with silicone sealing washer
Designed for use with basin with no bowl overflows
Durable brass construction

RRP (exc. GST) \$67.00
RRP (inc. GST) \$73.70

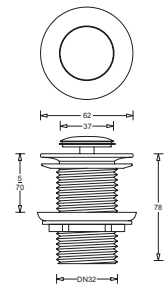

EMILIA/ QUADO/ LUCCA SHROUD

J3168

Basin shroud
Compatible with:
Quado basins: J3160, J3162, J3166, J3162, J3164
Emilia basins: J3142, J3144
Lucca basins: J3170L, J3170R

RRP (exc. GST) \$193.00
RRP (inc. GST) \$212.30



COMO WB SHROUD (NO BRACKET)

J3187A

Basin shroud
Compatible with:
Como Basins: J3180

RRP (exc. GST) \$251.00
RRP (inc. GST) \$276.10



OPTIONAL PARTS



BOSTON SHROUD (SUITS TYPE B & C)

J3189	RRP (exc. GST) \$229.00	RRP (inc. GST) \$251.90
Basin shroud Compatible with Boston Type B(J3092) and C (J3094)		



EMILIA MK II SHROUD

JBSE461	RRP (exc. GST) \$169.00	RRP (inc. GST) \$185.90
Basin shroud Compatible with: Emilia MK II Wall Basin		



LIFE II SHROUD

JBSL852	RRP (exc. GST) \$169.00	RRP (inc. GST) \$185.90
Shoud for Life II basin		

COLONIAL PEDESTAL 300X300X520

JBSC830	RRP (exc. GST) \$227.00	RRP (inc. GST) \$249.70
Pedestal for Colonial basin		



EMILIA/ QUADO PEDESTAL

J3149	RRP (exc. GST) \$269.00	RRP (inc. GST) \$295.90
Basin pedestal Compatible with: Emilia basins: J3142, J3144 Quado basins: J3162, J3164, J3166		





HIGH PERFORMANCE RIMLESS FLUSHING

Rimless toilets use a direct flushing system which distributes the cleansing water around the pan more effectively. This results in more efficient flushing.



ADVANCED RIMLESS DESIGN FOR HYGIENIC FLUSHING

The rim areas of traditional bowls are difficult to clean resulting in unhygienic grime and germ build up. In contrast, rimless toilet pans are easily cleaned and the efficient flushing system provides a more hygienic day to day experience.



VC Replacement 25 year warranty

25 years products replacement for all Vitreous China basins, toilets and urinals.



Toilet Seats 5 year warranty

5 years product/parts replacement for all toilet seats.



Comfort Height

Adapted products to aid mobility and to assist people with disabilities and reduced mobility.



Soft-close system

The toilet seat lid with soft-close system avoids shocks and breakages.



Anti-vandal system

Hidden fixings that require a tool to remove. Provides an anti-theft protection.



Ambulant Compliant

These products are suitable for people with ambulant limitations (AS1428.1 compliant)



Accessible

Adapted products to aid mobility and to assist people with disabilities and reduced mobility.



*All Toilet Suites rated WELS 4 Star 4.5L/3L unless otherwise stated

TOILET SUITES

Manufactured from high quality vitreous china Johnson Suisse develops contemporary universal designs without compromising on strength or durability. The exceptional strength and complex designs achievable can be attributed to Johnson Suisse innovative approach to flushing performance, which embraces superior quality and precise engineering backed by a 25 year vitreous china warranty.



TOILET TYPES



Flush To Wall



Closed Coupled

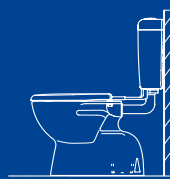

Linked



Wall Faced



Wall Hung

BACK TO WALL



LISTO BTW RIMLESS SMART TOILET SUITE

Code	RRP (exc. GST)	RRP (inc. GST)
JSTL400	\$3,909.00	\$4,299.90

- Johnson Suisse Listo Smart Toilets have an Integral High Hazard Backflow Prevention device which complies with the requirements of AS 2845.2 (1996 and 2010) and AS/NZS 3500.1. Meaning no additional RPZ valve is required
- Smart Shower Toilet - rimless vitreous china with integrated shower bidet and drying functions
- Automatic user detection and convenient nightlight
- Frontal and rear shower cleansing functions - adjustable nozzle positioning, temperature and pressure
- Comfort drying function - adjustable temperature
- Automatic nozzle cleaning function
- Soft-close, quick-release toilet seat
- Remote and seat-mounted control
- 25 years product replacement (VC only), 1 year toilet seat and electrical
- WELS 4 Star, 4.6/3.1L (3.3L average flush) L07698

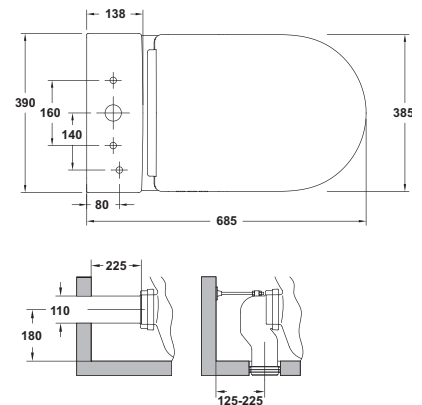
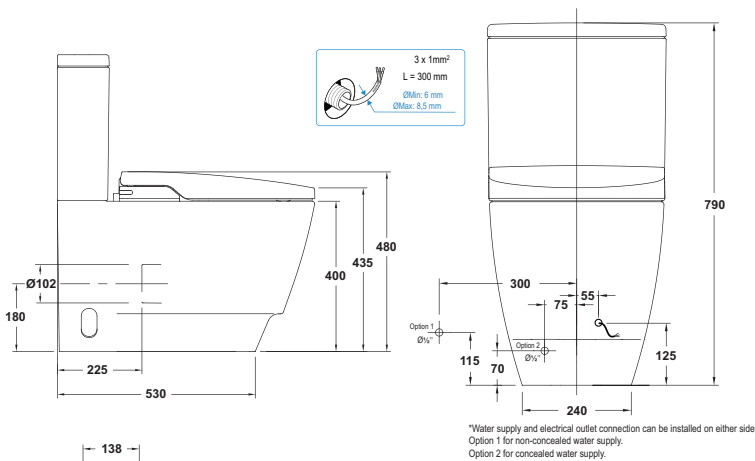

GEMELLI BTW RIMLESS TOILET SUITE W/SEAT

Code	RRP (exc. GST)	RRP (inc. GST)
JTTG301.JTTG302.712	\$635.00	\$698.50

- Curved front, back to wall vitreous china toilet suite
- Efficient rimless design for hygienic flushing
- Compatible for rear or bottom inlet
- Soft-close, quick release toilet seat made of Duroplast (Urea) material
- S or P trap configuration installation
- Variable S trap pan connector (95-200mm set out)
- WELS 4 Star, 4.5/3.2L (3.5L average flush) L06969

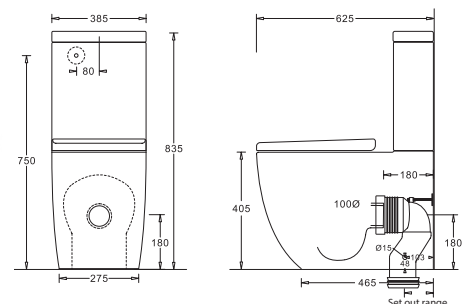

Optional Parts (not included)

Flush button 48mm Matte Black		
XJ207 Chrome	\$44.00	\$48.40
XJ207MB Matte Black	\$44.00	\$48.40
XJ207GM Gun Metal	\$44.00	\$48.40
XJ207BN Brushed Nickel	\$44.00	\$48.40
XJ207BB Brushed Brass	\$44.00	\$48.40

BACK TO WALL



VENEZIA COMPACT BTW RIMLESS TOILET SUITE W/SEAT

Code **RRP (exc. GST)** **RRP (inc. GST)**
 JTTV321.JTTV312.311 \$600.00 \$660.00

- Modern style back to wall vitreous china toilet suite
- Efficient rimless design for hygienic flushing
- Compatible for rear or bottom inlet
- Soft-close, quick release toilet seat made of Duroplast (Urea) material
- S or P trap configuration installation
- Variable S trap pan connector (95-185mm set out)
- WELS 4 Star, 4.5/3L (3.3L average flush) L06875

Optional Parts (not included)

Anti-Vandal Kit Incl 48mm Button

XJ123B \$72.00 \$79.20

Flush button 48mm Matte Black

XJ207 Chrome \$44.00 \$48.40

XJ207MB Matte Black \$44.00 \$48.40

XJ207GM Gun Metal \$44.00 \$48.40

XJ207BN Brushed Nickel \$44.00 \$48.40

XJ207BB Brushed Brass \$44.00 \$48.40

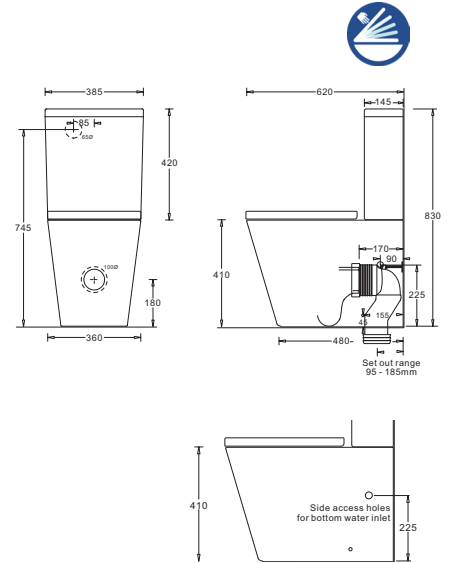

VENEZIA COMFORT BTW RIMLESS TOILET SUITE W/SEAT

Code **RRP (exc. GST)** **RRP (inc. GST)**
 JTTV331.JTTV333.315 \$627.00 \$689.70

- Modern style back to wall vitreous china toilet suite
- Efficient rimless design for hygienic flushing
- Comfort height pan for ease of use
- Compatible for rear or bottom inlet
- Soft-close, quick release toilet seat made of Duroplast (Urea) material
- S or P trap configuration installation
- Variable S trap pan connector (110-200mm set out)
- WELS 4 Star, 4.7/2.9L (3.3L average flush) L06872

Optional Parts (not included)

Anti-Vandal Kit Incl 48mm Button

XJ123B \$72.00 \$79.20

Flush button 48mm Matte Black

XJ207 Chrome \$44.00 \$48.40

XJ207MB Matte Black \$44.00 \$48.40

XJ207GM Gun Metal \$44.00 \$48.40

XJ207BN Brushed Nickel \$44.00 \$48.40

XJ207BB Brushed Brass \$44.00 \$48.40

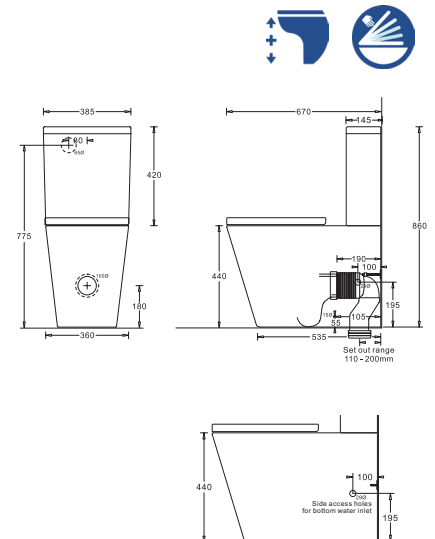

VENEZIA AMBULANT BTW RIMLESS SUITE W/SEAT

Code **RRP (exc. GST)** **RRP (inc. GST)**
 JTTV301.J2371.101 \$733.00 \$806.30

- Modern style back to wall vitreous china toilet suite
- Efficient rimless design for hygienic flushing
- Ambulant Compliant (to AS1428.1) back to wall vitreous china toilet suite
- Efficient rimless design for hygienic flushing
- Cistern with concealed back entry water inlet
- Soft-close, quick release toilet seat made of Duroplast (Urea) material
- S or P trap configuration installation
- Variable S trap pan connector (90-190mm set out)
- WELS 4 Star, 4.5/3.1L (3.4L average flush) L06869
- **Phasing Out 2024**

Optional Parts (not included)

Anti-Vandal Kit Incl 38mm Button

XJ122A \$63.00 \$69.30

Flush Button 38mm Matte Black

XJ140B \$42.00 \$46.20

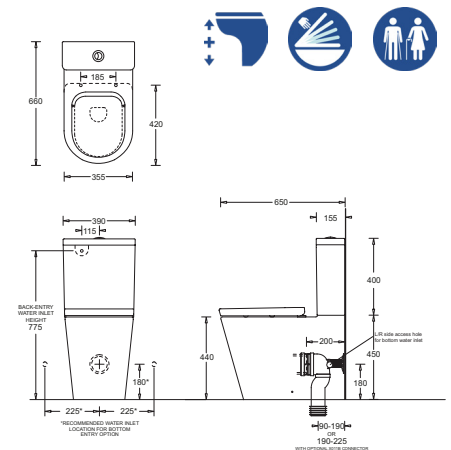

BACK TO WALL



EMILIA RIMLESS

Code	RRP (exc. GST)	RRP (inc. GST)
JTTE405.JTTE406.105	\$562.00	\$618.20
JTTE405.JTTE406.110	\$515.00	\$566.50

- Smartly styled back to wall vitreous china toilet suite
- Rimless design for hygienic flush efficiency
- Supplied with soft close seat as standard
- Compatible for rear or bottom inlet
- Adjustable S connector supplied for 100-160mm set out
- Optional adjustable S connector for 160-200mm set out
- S or P Trap configuration installation
- WELS 4 Star, 4.5/3.1L (3.3L average flush) L06750

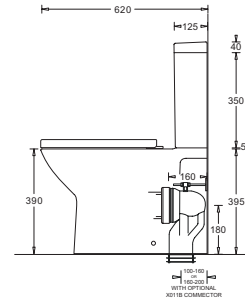

Product shown with the JSEE105 seat

EMILIA XTRA (RIMLESS)

Code	RRP (exc. GST)	RRP (inc. GST)
JTTE401.402.X011H	\$609.00	\$669.90

- Contemporary BTW, CC, Rimless, vitreous china toilet suite
- Extra height and short projection makes it suitable for people with ambulant limitations (AS1428.1 compliant)
- Supplied with soft close seat as standard
- 4 Star dual flush efficiency
- Concealed back entry water inlet.
- Left/right hand bottom entry conversion valve available
- Adjustable S connector supplied for 90-140mm set out
- Optional adjustable S connector for 140-200mm set out
- S or P Trap configuration installation
- WELS 4 Star, 4.6/3.1L (3.4 average flush) L06639

Optional Parts (not included)

Anti Vandal Fitting XJ122A	\$63.00	\$69.30
Adjustable S connector for 140-200mm set out X011B	\$67.00	\$73.70

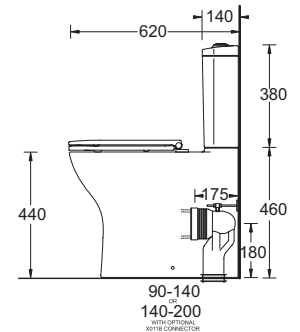

TOLEDO XTRA (RIMLESS)

Code	RRP (exc. GST)	RRP (inc. GST)
JTTT401.JTTT402.E101	\$668.00	\$734.80

- Smartly styled back to wall close coupled vitreous china toilet suite
- Rimless flushing system - efficient and easy to clean
- Supplied with Toledo soft close quick release seat MSEE101
- Can be used in ambulant-assisted living installations with the increased seat height for comfortable use (AS1428.1 Ambulant compliant)
- Concealed back entry water inlet
- Adjustable S connector supplied for 90-175mm set out
- Optional adjustable S connector for 175-210mm set out
- WELS 4 Star, 4.5/3L (3.2 average flush) L06645

Optional Parts (not included)

Anti Vandal Fitting XJ122A	\$63.00	\$69.30
Adjustable S connector for 140-200mm set out X011B	\$67.00	\$73.70

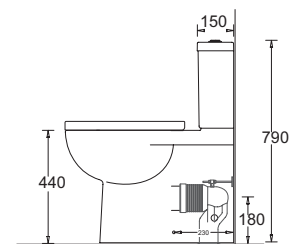

WALL FACED



GEMELLI WF RIMLESS PAN W/SEAT

Code JTTG711.715 **RRP (exc. GST)** \$545.00 **RRP (inc. GST)** \$599.50

- Curved front wall faced vitreous china toilet pan
- Efficient rimless design for hygienic flushing
- Concealed wall mounting system
- Soft-close, quick release toilet seat made of Duroplast (Urea) material
- S or P trap configuration installation
- Variable S trap pan connector (120-145mm set out)
- Pneumatic Push Buttons for Econoflush In-Wall cistern - see page p.6
- WELS 4 Star, 4.5/3.L (3.3L average flush) L06861

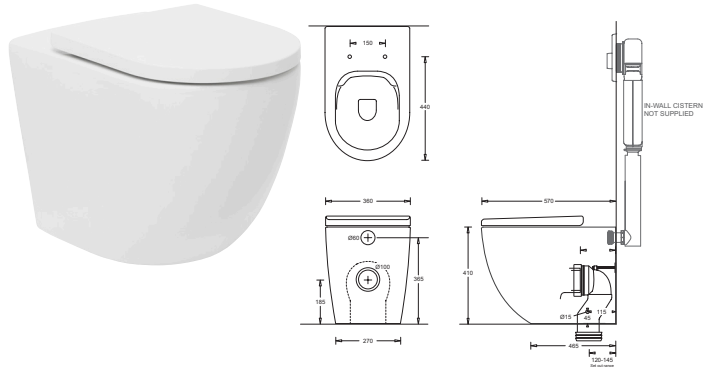

VENEZIA WF RIMLESS PAN W/SEAT

Code JTTV611.315 **RRP (exc. GST)** \$490.00 **RRP (inc. GST)** \$539.00

- Modern style wall faced vitreous china toilet suite
- Efficient rimless design for hygienic flushing
- Short projection pan suitable for small bathrooms
- Soft-close, quick release toilet seat made of Duroplast (Urea) material
- Comfort height pan for ease of use
- S or p trap configuration installation
- Variable s trap pan connector (115-145mm set out)
- Pneumatic Push Buttons for Econoflush In-Wall cistern - see page p.6
- WELS 4 Star, 4.5/2.9L (3.2L average flush) L06871

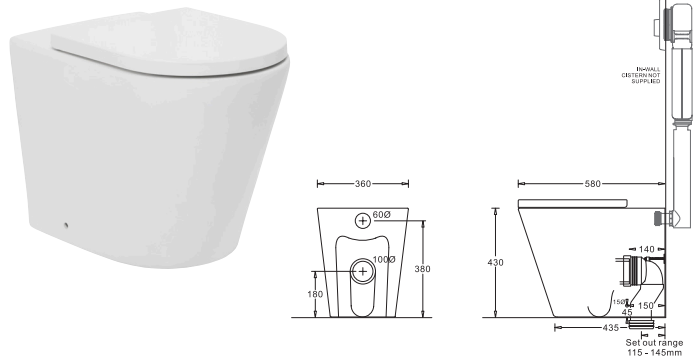

TOLEDO WALL FACED RIMLESS PAN

Code JTTT601.MSEE101 **RRP (exc. GST)** \$452.00 **RRP (inc. GST)** \$497.20

- Rimless wall-faced pan
- This wall-faced pan with inwall cistern combination is suitable for commercial or domestic applications
- Extra-height pan suitable for assisted living/ambulant installations
- Optional Vandal-resistant seat available
- Minimum 90mm cavity depth
- S trap set out 90-120mm P trap set out 180mm
- Pneumatic Push Buttons for Econoflush In-Wall cistern - see page p.6
- WELS 4 Star, 4.6/3L (3.3 average flush) L06670

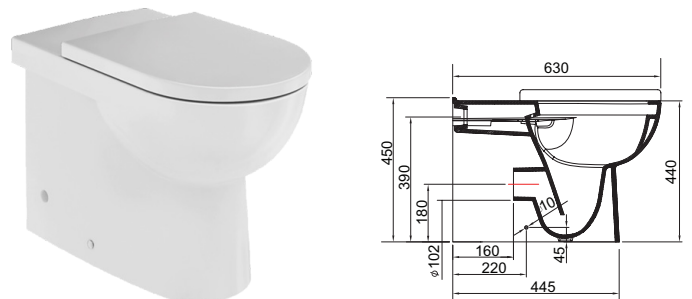

WALL HUNG



GEMELLI WH RIMLESS PAN W/SEAT

Code JTTG705.712 **RRP (exc. GST)** \$545.00 **RRP (inc. GST)** \$599.50

- Curved front wall hung vitreous china toilet pan
- Efficient rimless design for hygienic flushing
- Concealed wall mounting system
- Soft-close, quick release toilet seat made of Duroplast (Urea) material
- Mechanical Push Buttons for Econoflush In-Wall cistern - see page p.7
- WELS 4 Star, 4.5/3L (3.3L average flush) L06873

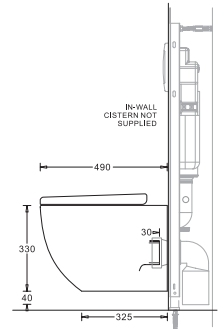
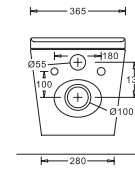

VENEZIA WH RIMLESS PAN W/SEAT

Code JTTV711.315 **RRP (exc. GST)** \$490.00 **RRP (inc. GST)** \$539.00

- Modern style wall hung vitreous china toilet suite
- Efficient rimless design for hygienic flushing
- Short projection pan suitable for small bathrooms
- Soft-close, quick release toilet seat made of Duroplast (Urea) material
- Mechanical Push Buttons for Econoflush In-Wall cistern - see page p.7
- WELS 4 Star, 4.5/3L (3.3L average flush) L06861

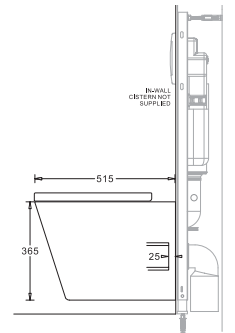
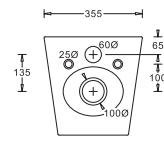

IN-WALL SYSTEM PNEUMATIC

ECONOFLUSH AIR UNFRAMED (Pneumatic)

Code	RRP (exc. GST)	RRP (inc. GST)
J2982A	\$488.00	\$536.80

- Concealed in-wall cistern with integrated mounting / pan fixing frame
- Space efficient and suitable for commercial or domestic installations
- Can be matched with a variety of wall - faced pans
- Selection of cistern actuator buttons available
- Optional remote pneumatic cistern actuation - buttons can be connected via air tube (4m long)
- WELS 4 Star, 4.6/3.1L (3.4L average flush) L06740

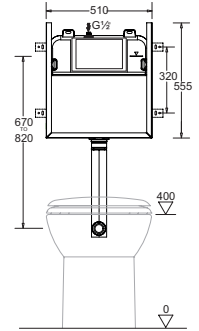

REMOTE INSTALLATION KIT FOR PNEUMATIC BUTTON

Code	RRP (exc. GST)	RRP (inc. GST)
JB92K	\$197.00	\$216.70

- Specifically purposed to enable the mounting of Pneumatic Buttons anywhere in your bathroom yet still have access to the cistern. (up to 4m away from the cistern)
- Available for Induct, Inceiling, Inwall or Undercounter installations
- Ideal for applications where space is a premium
- Buttons and panels Sold Separately



PNEUMATIC BUTTONS FOR ECONOFLUSH IN-WALL CISTERNS



PNEUMATIC RAISED BUTTON BLUE

Code	RRP (exc. GST)	RRP (inc. GST)
JB90B - Blue	\$246.00	\$270.60



PNEUMATIC RAISED BUTTON CHROME

Code	RRP (exc. GST)	RRP (inc. GST)
JB90C - Chrome	\$246.00	\$270.60

IN-WALL ECONOFLUSH SS BUTTON PLATE ONLY INCL SCREWS

Code	RRP (exc. GST)	RRP (inc. GST)
JB90SSP - Stainless Steel	\$290.00	\$319.00



PNEUMATIC FLAT BUTTON

Code	RRP (exc. GST)	RRP (inc. GST)
JB92W - White	\$246.00	\$270.60
JB92C - Polished Chrome	\$246.00	\$270.60
JB92M - Matt Chrome	\$246.00	\$270.60



PNEUMATIC FLAT BUTTON BLACK

Code	RRP (exc. GST)	RRP (inc. GST)
JB92BLK - Black	\$246.00	\$270.60

IN-WALL SYSTEM MECHANICAL

ECONOFLUSH UNFRAMED

Code	RRP (exc. GST)	RRP (inc. GST)
J2981	\$488.00	\$536.80

- Unframed concealed in-wall cistern
- Space efficient and suitable for commercial or domestic installations
- Can be matched with a variety of wall-faced pans
- Selection of cistern actuator buttons available
- WELS 4 Star, 4.6/3.1L (3.4L average flush) L06738

Optional Parts (not included)

Extended push-button rods XR920	\$44.00	\$48.40
---------------------------------	---------	---------

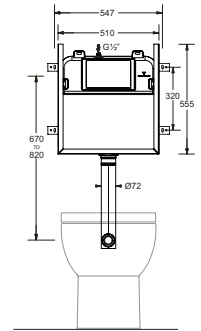

ECONOFLUSH FRAMED

Code	RRP (exc. GST)	RRP (inc. GST)
J2986	\$597.00	\$656.70

- Concealed in-wall cistern with integrated mounting / pan fixing frame
- Space efficient and suitable for commercial or domestic installations
- Can be matched with a variety of wall-hung pans
- S/P pan connectors and pan fixing bolts included
- Selection of cistern actuator buttons available
- WELS 4 Star, 4.6/3.1L (3.4L average flush) L06739

Optional Parts (not included)

Extended push-button rods XR920	\$44.00	\$48.40
---------------------------------	---------	---------

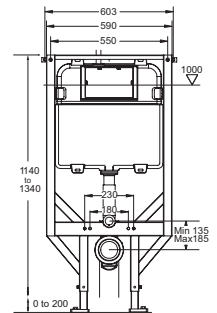
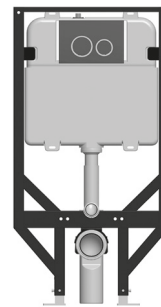

MECHANICAL FLUSH PLATE/BUTTONS FOR ECONOFLUSH IN - WALL CISTERNS

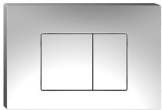

RECTANGLE HIGH BUTTON

Code	RRP (exc. GST)	RRP (inc. GST)
JB60C - Chrome	\$186.00	\$204.60
JB60M - Matt Chrome	\$186.00	\$204.60

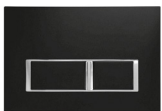

RECTANGLE LOW BUTTON

Code	RRP (exc. GST)	RRP (inc. GST)
JB50C - Chrome	\$186.00	\$204.60
JB50M - Matt Chrome	\$186.00	\$204.60
JB50B - Black	\$186.00	\$204.60
JB50W - White	\$186.00	\$204.60



CIRCLE BUTTON

Code	RRP (exc. GST)	RRP (inc. GST)
JB80C - Chrome	\$186.00	\$204.60
JB80M - Matt Chrome	\$186.00	\$204.60
JB80B - Black	\$186.00	\$204.60
JB80W - White	\$186.00	\$204.60



STEP BUTTON

Code	RRP (exc. GST)	RRP (inc. GST)
JB40C - Chrome	\$186.00	\$204.60
JB40M - Matt Chrome	\$186.00	\$204.60



ROUND SQUARE BUTTON

Code	RRP (exc. GST)	RRP (inc. GST)
JB70C - Chrome	\$186.00	\$204.60
JB70M - Matt Chrome	\$186.00	\$204.60
JB70B - Black	\$186.00	\$204.60
JB70W - White	\$186.00	\$204.60

CLOSE COUPLED



MILANO

Code	RRP (exc. GST)	RRP (inc. GST)
J1424 (S Trap)	\$434.00	\$477.40

- Modern design
- Compact lines
- Suitable for new or replacement installations
- Secure, external cistern fixing
- L/R adjustable water inlet
- S Trap set out 140mm
- WELS 4 Star, 4.6/3.1L (3.4L average flush) L06684

Optional Parts (not included)

Anti Vandal Fitting XJ122B	\$66.00	\$72.60
----------------------------	---------	---------

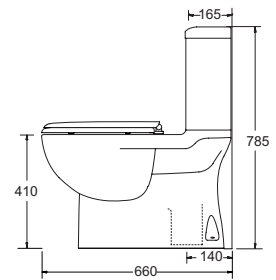

COLONIAL II

Code	RRP (exc. GST)	RRP (inc. GST)
Mahogany Timber Seat/Chrome Trim J2010.J2400C.MC (S Trap)	\$723.00	\$795.30
Oak Timber Seat/Chrome Trim J2010.J2400C.OC (S Trap)	\$723.00	\$795.30
White Seat/Chrome Trim J2010.J2400C.WC (S Trap)	\$723.00	\$795.30
Mahogany Timber Seat/Chrome Trim J2011.J2400C.MC (P Trap)	\$723.00	\$795.30
Oak Timber Seat/Chrome Trim J2011.J2400C.OC (P Trap)	\$723.00	\$795.30
White Seat/Chrome Trim J2011.J2400C.WC (P Trap)	\$723.00	\$795.30

- Colonial design close coupled suite
- Secure, external cistern fixing
- L/R water inlet
- Soft close or Timber seat
- WELS 4 Star, 4.5/3L (3.3L average flush) L06779

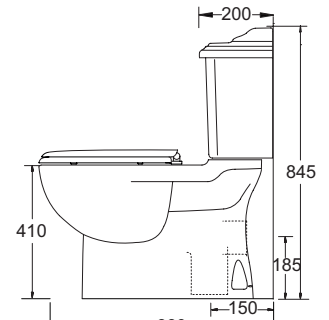

SPACE SOLUTION

Code	RRP (exc. GST)	RRP (inc. GST)
C6799.C6269.X011H	\$1,170.00	\$1,287.00
C6799.C6269.X011B	\$1,170.00	\$1,287.00

- Contemporary design style
- Elegant, compact suite
- Easy-clean HYGIENE@ glaze
- Flexible set out range - 90 -200mm (X011H)
- Connector 180-270 mm Set Out (X011B)
- S or P Trap
- WELS 4 Star, 4.5/2.8L (3.3L average flush) L06617

Optional Parts (not included)

Anti Vandal Fitting XJ122A	\$63.00	\$69.30
----------------------------	---------	---------

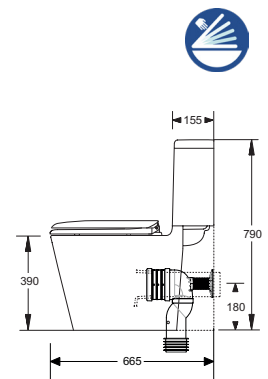

SPACE SOLUTION SKEW

Code	RRP (exc. GST)	RRP (inc. GST)
C6799.C6269.SK	\$1,198.00	\$1,317.80

- Contemporary design style
- Elegant, compact skew suite ideal for limited space installations
- Easy-clean HYGIENE@ glaze
- Side bend connector(90°)
- WELS 4 Star, 4.5/2.8L (3.3L average flush) L06617

Optional Parts (not included)

Anti Vandal Fitting XJ122A	\$63.00	\$69.30
----------------------------	---------	---------

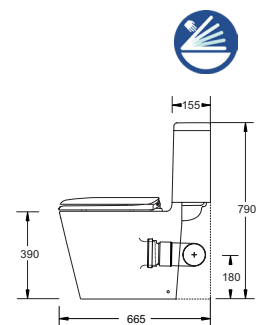

CLOSE COUPLED



EGG JUNIOR

Code	RRP (exc. GST)	RRP (inc. GST)
White Cistern Lid		
C67977.C6262.11H.W	\$1,175.00	\$1,292.50
Blue Cistern Lid		
C67977.C6262.11H.B	\$1,175.00	\$1,292.50
Lemon Yellow Cistern Lid		
C67977.C6262.11H.L	\$1,175.00	\$1,292.50
Rose Apple (Pink) Cistern Lid		
C67977.C6262.11H.P	\$1,175.00	\$1,292.50
Kiwi Cistern Lid		
C67977.C6262.11H.K	\$1,175.00	\$1,292.50

- Child friendly, fun egg-shaped vitreous china close coupled toilet suite
- Coloured ceramic cistern lid in - Green, Yellow, Pink, Blue or White
- Low seat height suitable for children up to 12yrs
- Bowl finished in HYGIENE glaze for easy cleaning
- Includes a child safe soft close, quick release toilet seat
- Right hand water inlet
- Adjustable connector to achieve 90-160mm set out (X011H)
- Optional adjustable connector to achieve 160-200 mm set out (X011B) and Anti Vandal Fitting (XJ122A)
- WELS 4 Star, 4.5/3L dual flush

Optional Parts (not included)

Anti Vandal Fitting XJ122A	\$63.00	\$69.30
Adjustable S connector for 140-200mm set out X011B	\$67.00	\$73.70

When correctly installed this toilet suite will comply with AS1428.3 for age groups (a) and (b) (i.e. 3 to 10½ years old) within disability groups A and S (i.e. ambulant limitations)



LINKED VITREOUS CHINA



MERGE DELUXE

Code J2030.MTTM201 (S Trap) **RRP (exc. GST)** \$354.00 **RRP (inc. GST)** \$389.40

- Functional stylish design
- Concealed outlet pan matched with vitreous china cistern
- Standard close seat with fitted plastic link
- Suitable for new or replacement installations
- Flexible S Trap set out range 150 - 250mm
- L /R Adjustable water inlet
- S Trap
- Pan - WELS 4 Star, 4.6/3.2L (3.5L average flush) L06600, Cistern - WELS 4 Star, 4.4/3L (3.3L average flush) L06632
- **Phasing Out 2024**

Optional Parts *(not included)*

Anti Vandal Fitting XJ122B \$66.00 \$72.60

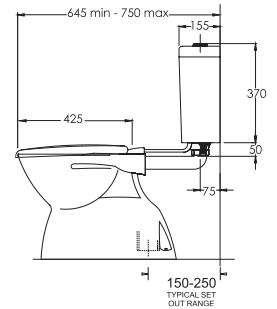

MERGE SKEW

Code J2001A.MTTM201.SK **RRP (exc. GST)** \$428.00 **RRP (inc. GST)** \$470.80

- Standard pedestal P trap vitreous china pan
- Designed for general purpose use in commercial or domestic skew installations allowing a flexible set out in both distance to wall, and height from floor
- Quality glaze finish
- Ideally matched with BPA wall mounted cisterns
- 4 hole floor fixing for increased stability
- Efficient, reliable flushing performance

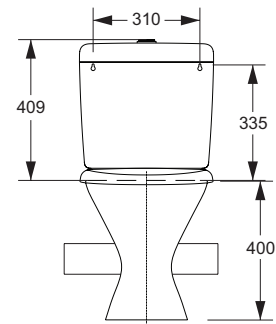

LINKED VITREOUS CHINA



COLONIAL FEATURE

Code	RRP (exc. GST)	RRP (inc. GST)
Mahogany Chrome J2050.J2401M.C	\$982.00	\$1,080.20
Oak Chrome J2050.J2401O.C	\$982.00	\$1,080.20
White Chrome J2050.J2401M.CW	\$982.00	\$1,080.20

- Colonial style with embossed edging features
- Exposed chrome flush pipe
- Matching timber seat options
- Suitable for new or replacement installations
- Flexible S Trap set out range - 180 -280mm
- L /R Adjustable water inlet
- S Trap
- WELS 4 Star, 4.6/3.1L (3.4 average flush) L06675

Optional Parts *(not included)*

Anti Vandal Fitting XJ122A	\$63.00	\$69.30
----------------------------	---------	---------

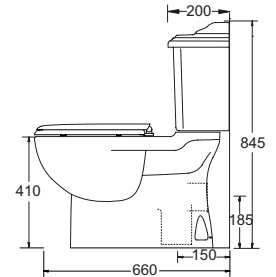

LINKED PLASTIC

WINDSOR

Code	RRP (exc. GST)	RRP (inc. GST)
J2000A.G1200A (S Trap)	\$219.00	\$240.90
J2001A.G1200A (P Trap)	\$219.00	\$240.90

- Traditional design
- Standard pedestal pan matched with Windsor plastic cistern
- Standard close seat with fitted plastic link
- Suitable for new or replacement installations
- Flexible S Trap set out range 120 -280mm
- L /R Adjustable water inlet
- Single carton packaging
- S or P Trap
- Convertible to 6/3L and 9/4.5L
- WELS 4 Star, 4.6/3.2L (3.5 average flush) L06805

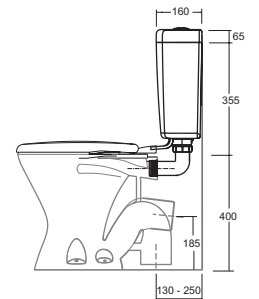

LINKED PLASTIC



MODE

Code	RRP (exc. GST)	RRP (inc. GST)
J2000.G1210 (S Trap)	\$210.00	\$231.00
J2001.G1210 (P Trap)	\$210.00	\$231.00

- Compact design
- Standard pedestal pan matched with Mode plastic cistern
- Standard close seat with fitted plastic link
- Suitable for new or replacement installations
- Flexible set out range
- Flexible S Trap set out range 120 -280mm
- Single carton packaging
- S or P Trap
- WELS 4 Star, 4.6/3.1L (3.4 average flush) L06642

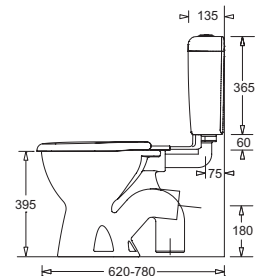

MODE II SKEW

Code	RRP (exc. GST)	RRP (inc. GST)
J2001A.G1210A.SK	\$367.00	\$403.70

- Standard pedestal P trap vitreous china pan
- Designed for general purpose use in commercial or domestic skew installations allowing a flexible set out in both distance to wall, and height from floor
- Quality glaze finish
- Ideally matched with BPA wall mounted cisterns
- 4 hole floor fixing for increased stability
- Efficient, reliable flushing performance

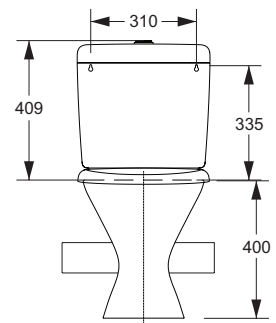

MODE DELUXE

Code	RRP (exc. GST)	RRP (inc. GST)
J2030.G1210	\$262.00	\$288.20

- Compact design
- Standard pedestal pan matched with Mode plastic cistern
- Standard close seat with fitted plastic link
- Suitable for new or replacement installations
- Flexible set out range
- Flexible S Trap set out range 120 -280mm
- Single carton packaging
- S Trap
- WELS 4 Star, 4.6/3.1L (3.4L average flush) L06643

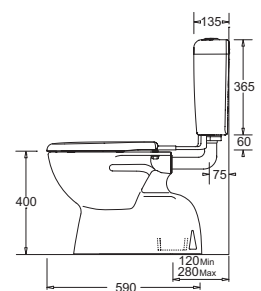

TOILET PANS

MODE STRAP

Code
J2000A

RRP (exc. GST) \$177.00 **RRP (inc. GST)** \$194.70

- Standard pedestal S pan
- Designed for general purpose use
- Suitable for domestic or commercial installations
- 4 hole fixing for stability
- Fits both keeseal and flush cone flush pipe connections
- Efficient reliable flushing performance

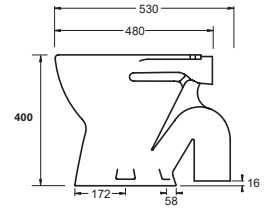

MODE PTRAP

Code
J2001A

RRP (exc. GST) \$177.00 **RRP (inc. GST)** \$194.70

- Standard pedestal P pan
- Designed for general purpose use
- Suitable for domestic or commercial installations
- 4 hole fixing for stability
- Fits both keeseal and flush cone flush pipe connections
- Efficient reliable flushing performance
- Long spigot for improved seal

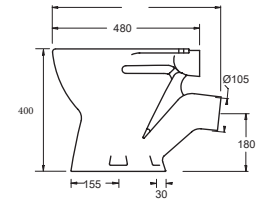

MODE DELUXE STRAP

Code
J2030A

RRP (exc. GST) \$193.00 **RRP (inc. GST)** \$212.30

- Concealed outlet S pan
- Designed for general purpose use
- Suitable for domestic or commercial installations
- Fits keeseal flush pipe connections
- Efficient reliable flushing performance

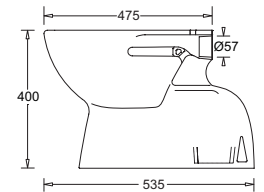

WALL MOUNT VC CISTERNS



MERGE

Code
MTTM201

RRP (exc. GST)	RRP (inc. GST)
\$282.00	\$310.20

- Stylish Vitreous China cistern with link and seat
- Durable materials and components
- Large chrome-plated flush buttons
- 4.5/3L Dual flush - 4 Star WELS rated
- Adjustable to suit 6.0 /3L flushing pans
- Bottom entry, RH Water Inlet

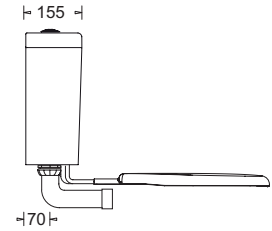

PLAZA

Code
J2201W

RRP (exc. GST)	RRP (inc. GST)
\$360.00	\$396.00

- Vitreous china wall mounted cistern
- Designed for general purpose use
- Plastic seat, link, flush pipe and seals
- 4.5/3L flushing, convertible to 6/3L
- Efficient reliable flushing performance
- Soft-close seat
- LH/RH Water Inlet

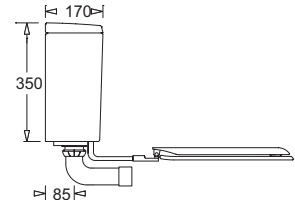

COLONIAL FEATURE

Code
J2401M.C

RRP (exc. GST)	RRP (inc. GST)
\$606.00	\$666.60

- Period style vitreous china wall mounted cistern
- Efficient reliable flushing performance
- Cistern with Chrome Button and Flush Pipe
- 4.5/3L Dual flush
- LH/RH water inlet
- Can be used in a close coupled configuration in the Colonial Close Coupled suite
- Convertible to 6/3L
- Can be used as a wall-mounted unit in the Colonial Feature suite

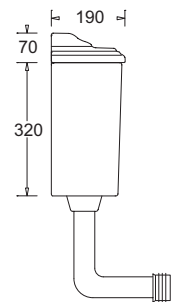

WALL MOUNT PLASTIC CISTERNS



WINDSOR

Code
G1200A

RRP (exc. GST) \$145.00 **RRP (inc. GST)** \$159.50

- Standard plastic cistern with link and seat
- Design allows for flexible set out range (typically 140-300mm)
- Convertible to 6/3L Dual flush for use with 6L pans
- Generous in size. Ideal for replacement of older style cisterns.
- 4.5/3L Dual flush - 4 Star WELS rated
- Allows both Mid and Low-level installation
- Convertible to 9/4.5L Dual flush for use with older pans
- LH/RH Water Inlet

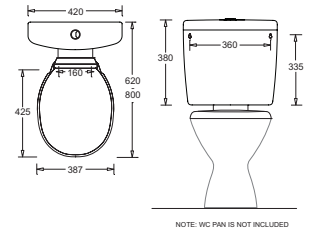

MODE II

Code
G1210A

RRP (exc. GST) \$122.00 **RRP (inc. GST)** \$134.20

- Stylish plastic cistern with link and seat
- Large chrome-plated buttons
- Design allows for flexible set out range (typically 150-260mm)
- 4.5/3L Dual flush - 4 Star WELS rated
- Adjustable to suit 6/3L flushing pans
- LH/RH water inlet

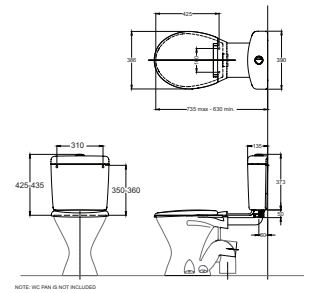

PULL CHAIN

Code
RG21015PC

RRP (exc. GST) \$492.00 **RRP (inc. GST)** \$541.20

- Plastic wall mounted high level urinal cistern
- Pull - chain flushing
- WELS 3 Star, 1.7L/min
- 1.5 - 2.0L flushing
- Efficient reliable flushing performance
- Includes 19mm pipe reducer

Optional Parts (not included)

Top Entry Urinal J6000 \$1,474.00 \$1,621.40

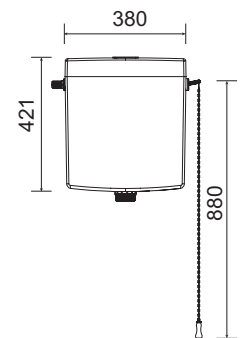

TOILET SEATS



SELECT / PLAZA DELUXE LINK

Code	RRP (exc. GST)	RRP (inc. GST)
RB1038SC	\$75.00	\$82.50

- Thermo-Plastic moulded medium duty
- Plastic hinges
- Includes link piece

Compatible with:

Mode
Mode Deluxe

Spare Parts

Plastic Bolt XR908A	\$29.00	\$31.90
Link XR906	\$24.00	\$26.40

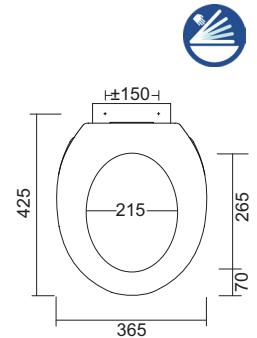

COLONIAL TIMBER

Code	RRP (exc. GST)	RRP (inc. GST)
Mahogany Seat 3000MC	\$134.00	\$147.40
Oak Seat 3000OC	\$134.00	\$147.40

- Wooden seat (mahogany or oak stain)
- Chrome hinges

Compatible with:

Colonial
Mode
Mode Deluxe

Spare Parts

Buffer XG30A	\$31.00	\$34.10
Anchor XJ194	\$22.00	\$24.20

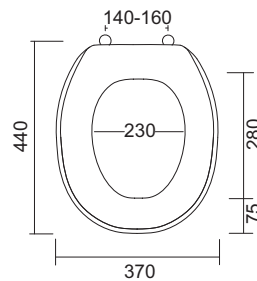

PLAZA

Code	RRP (exc. GST)	RRP (inc. GST)
RB6041	\$171.00	\$188.10

- Compression moulded seat
- Four moulded buffers
- Concealed top-fix soft close hinges with quick release
- Black rubber inserts XJ179B x 2

Compatible with:

Plaza
Civic
Mode
Mode Deluxe
Colonial Feature

Spare Parts

Hinge Metal XJ179	\$65.00	\$71.50
Buffer XJ187	\$33.00	\$36.30
Anchor XJ179A	\$22.00	\$24.20
Black rubber inserts x 2 XJ179B	\$22.00	\$24.20

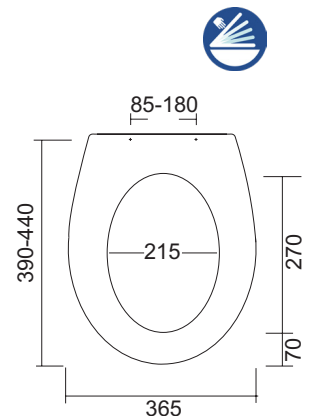

ESTI

Code	RRP (exc. GST)	RRP (inc. GST)
MSEE101	\$170.00	\$187.00

- Top-fix, soft close with quick release seat
- Urea material

Compatible with:

Toledo FTW Esti
Toledo WF Life
Emilia Heart

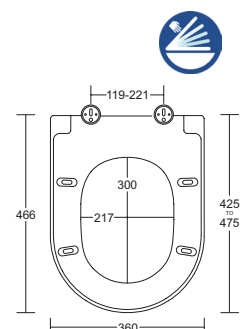

TOILET SEATS



COTTAGE

Code	RRP (exc. GST)	RRP (inc. GST)
G1027A	\$35.00	\$38.50
G1027ASC	\$48.00	\$52.80

- Non Soft close seat without link (G1027A)
- Soft Close seat with link (G1027ASC)
- Medium duty Thermo-Plastic moulded seat
- Plastic hinges

Compatible with:

Milano CC	Colonial II
Civic	Mode
Plaza	Mode Deluxe

Spare Parts

Seat Bolts X019	\$16.00	\$17.60
Link Holder X017	\$16.00	\$17.60
Link Piece X017A	\$27.00	\$29.70
Buffer X020	\$32.00	\$35.20
Hinge Pins for Seat /Pair X020B	\$16.00	\$17.60

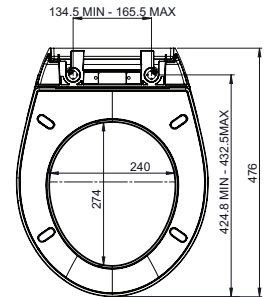

MODE II

Code	RRP (exc. GST)	RRP (inc. GST)
G1028A	\$54.00	\$59.40

- Standard duty Thermo-Plastic moulded seat
- Plastic hinges

Compatible with:

Mode
Mode Deluxe

Spare Parts

Seat Bolts X025A	\$16.00	\$17.60
Hinge Pins X025B	\$16.00	\$17.60
Link For Plastic Cistern X0255	\$24.00	\$26.40

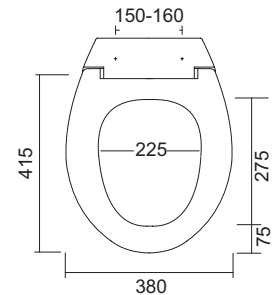

MILANO FTW

Code	RRP (exc. GST)	RRP (inc. GST)
J2810	\$170.00	\$187.00

- Compression moulded seat with four moulded buffers
- Top-fix soft close hinges

Compatible with:

Milano FTW

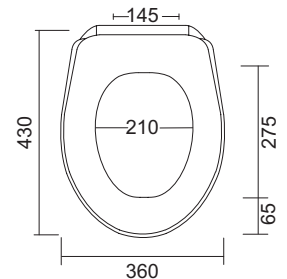

TOILET SEATS



VENEZIA FTW SEAT

Code	RRP (exc. GST)	RRP (inc. GST)
JSEV101	\$173.00	\$190.30

- Specific design for Venezia Flush To Wall Suite
- Compression moulded heavy duty
- Anti-bacterial
- Soft close, Quick release

Compatible with:
Venezia FTW

Spare Parts

Venezia / Esti Seat Hinges with buffer Set XJSV02	\$59.00	\$64.90
---	---------	---------

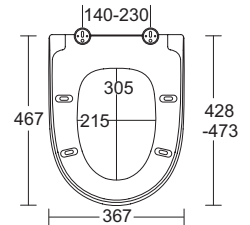

EMILIA

Code	RRP (exc. GST)	RRP (inc. GST)
JSEE101	\$189.00	\$207.90

- Top-fix, soft close, quick release

Compatible with:

Emilia FTW	Esti
Venezia FTW	Life
Toledo	Heart

Spare Parts

Emilia Seat Hinge	\$51.00	\$56.10
Pin & Bolt Set XJSEE01		

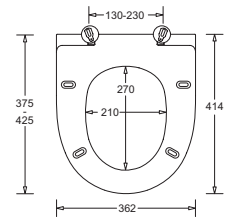

EGG JUNIOR

Code	RRP (exc. GST)	RRP (inc. GST)
JSEE202	\$177.00	\$194.70

- A child safe soft close, quick release toilet seat
- Low seat height suitable for children up to 12yrs

Compatible with:

Egg Junior Close Coupled Toilet Suite

Spare Parts

Pair of Hinges for Egg Junior seat XJ177D	\$77.00	\$84.70
---	---------	---------

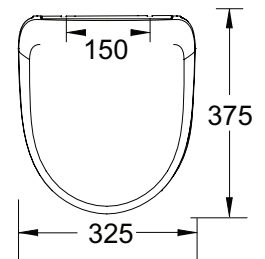

DELUXE

Code	RRP (exc. GST)	RRP (inc. GST)
C90801	\$173.00	\$190.30

- Compression moulded seat with soft close hinges
- Modern design and quality

Compatible with:

Proteus II
Space Solutions

Spare Parts

Hinge Metal XC9892	\$114.00	\$125.40
Buffer XC9817	\$38.00	\$41.80
Anchor XC981A	\$37.00	\$40.70

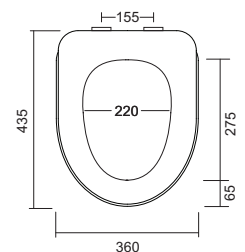

TOILET SEATS



GEMELLI COMPACT TOILET SEAT

Code JSEG712 **RRP (exc. GST)** \$197.00 **RRP (inc. GST)** \$216.70

- Top-Fix, Soft Close, Stainless Steel hinges
- Dual button quick release system
- Tough Duroplast (Urea) construction

Compatible with:

Gemelli Rimless FTW

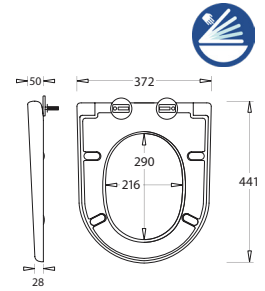

GEMELLI TOILET SEAT

Code JSEG715 **RRP (exc. GST)** \$179.00 **RRP (inc. GST)** \$196.90

- Top-Fix, Soft Close, Stainless Steel hinges
- Dual button quick release system
- Tough Duroplast (Urea) construction

Compatible with:

Gemelli Rimless WF/WH

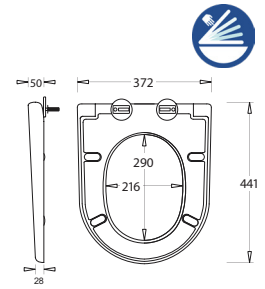

VENEZIA COMPACT TOILET SEAT

Code JSEV311 **RRP (exc. GST)** \$167.00 **RRP (inc. GST)** \$183.70

- Top-Fix, Soft Close, Stainless Steel hinges
- Dual button quick release system
- Tough Duroplast (Urea) construction

Compatible with:

Venezia Rimless FTW

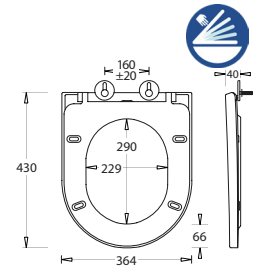

VENEZIA TOILET SEAT

Code JSEV315 **RRP (exc. GST)** \$164.00 **RRP (inc. GST)** \$180.40

- Top-Fix, Soft Close, Stainless Steel hinges
- Dual button quick release system
- Tough Duroplast (Urea) construction

Compatible with:

Venezia Rimless FTW
Venezia Rimless WF/WH

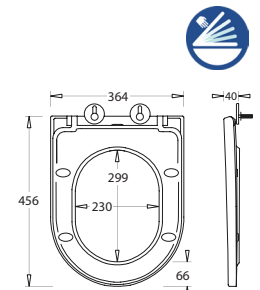

EMILIA TOILET SEAT

Code JSEE105 **RRP (exc. GST)** \$210.00 **RRP (inc. GST)** \$231.00

- Attractive Slim Style Toilet Seat
- Tough Duroplast (Urea) construction
- Soft-Close hinge with Stainless Steel mountings
- Quick release button for easy cleaning
- Top fixed mounting bolts

Compatible with:

Emilia Rimless FTW

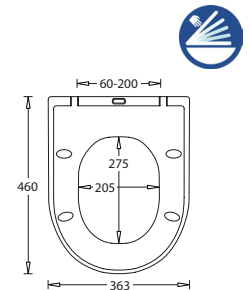

EMILIA RIMLESS SLIM

Code JSEE110 **RRP (exc. GST)** \$181.00 **RRP (inc. GST)** \$199.10

- Attractive Slim Style Toilet Seat
- Durable Polypropilene construction
- Soft-Close hinge with stainless steel mountings
- Quick release button for easy cleaning
- Top fixed mounting bolts

Compatible with:

Emilia Rimless FTW

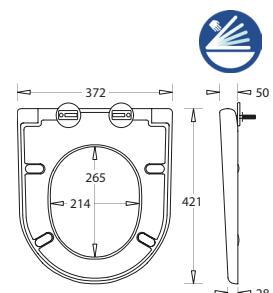

TOILET SEATS (ASSIST)



ASSIST +

Code	RRP (exc. GST)	RRP (inc. GST)*
RB6044B (Blue)	\$279.00	
RB6044W (White)	\$256.00	\$281.60
RB6044G (Grey)	\$279.00	

- Compression moulded seat with two moulded buffers
- Bolt-through stainless steel top fix hinges
- Includes adjustable lateral stabilisers

Compatible with:

Assist +
Life Assist FTW and WF

Spare Parts

Hinge Set Metal XR910	\$99.00	\$108.90
Buffer XR912	\$34.00	\$37.40
Stabiliser Blue XR911B	\$23.00	\$25.30
Stabiliser White XR911W	\$23.00	\$25.30
Stabiliser Grey XR911G	\$23.00	\$25.30

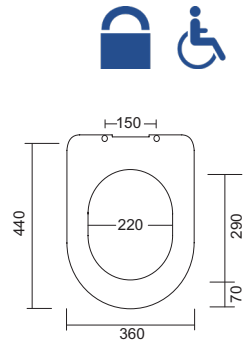

ASSIST

Code	RRP (exc. GST)	RRP (inc. GST)*
RB6015B (Blue)	\$244.00	
RB6015W (White)	\$210.00	\$231.00
RB6015G (Grey)	\$244.00	

- Compression moulded seat with two moulded buffers
- Bolt-through stainless steel top fix hinges
- Includes adjustable lateral stabilisers

Compatible with:

Assist
Mode Deluxe

Spare Parts

Hinge Set Metal XR909	\$99.00	\$108.90
Stabiliser Blue XR911B	\$23.00	\$25.30
Stabiliser White XR911W	\$23.00	\$25.30
Stabiliser Grey XR911G	\$23.00	\$25.30

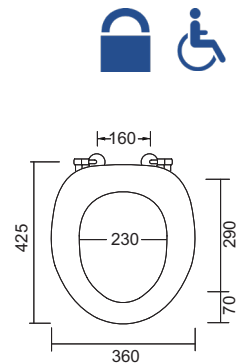

THE VENEZIA RANGE

Create a seamless bathroom design by using the Venezia range, designed together to provide an all-matching range of tapware, showers and accessories.

Personalise to your own taste by selecting from a range of colour options such as everlasting chrome, bold matte black or confident gun metal.



Scratch Resistant

These product finishes have high durability ideal for high usage areas.



Fingerprint Proof

These products resist fingerprints and clean easily ideal for high usage areas.

TAPWARE, SHOWERS & ACCESSORIES

Johnson Suisse tapware combines superior functionality with a classic aesthetic appeal. Endurance tested to the highest standards, the premium quality ceramic cartridge provides the optimum level of durability whilst the innovative aerated water stream reduces noise and prevents splashing.



JohnsonSuisse
Bathroom Solutions

TAPWARE, SHOWERS & ACCESSORIES

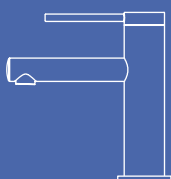

Bathroom & Kitchen Tapware

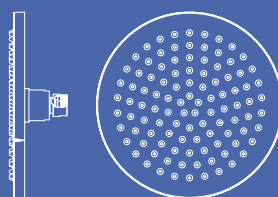

Showers

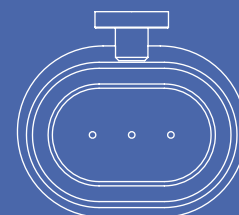

Accessories

TAPWARE

VENEZIA BASIN MIXER CHROME

JTV121CH

Basin mixer with ultra thin pin lever handle
 Chrome finish
 Durable brass body with 25mm ceramic disc
 Matching showers and accessories available
 Simple, secure fixing system
 WELS 6 Star, 4.5L/min T37931

RRP (exc. GST)
 \$217.00

RRP (inc. GST)
 \$238.70

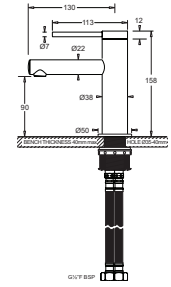

VENEZIA BASIN MIXER MATTE BLACK

JTV121EMB

Basin mixer with ultra thin pin lever handle
 Matte black finish
 Durable brass body with 25mm ceramic disc
 Matching showers and accessories available
 Simple, secure fixing system
 WELS 6 Star, 4.5L/min T37931

RRP (exc. GST)
 \$250.00

RRP (inc. GST)
 \$275.00

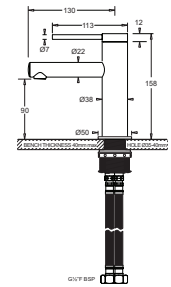

VENEZIA BASIN MIXER GUN METAL

JTV121EGM

Basin mixer with ultra thin pin lever handle
 Gun metal finish
 Durable brass body with 25mm ceramic disc
 Matching showers and accessories available
 Simple, secure fixing system
 WELS 6 Star, 4.5L/min T37931

RRP (exc. GST)
 \$300.00

RRP (inc. GST)
 \$330.00

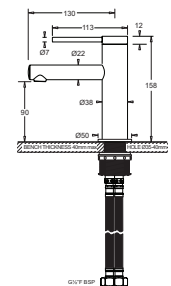

VENEZIA BASIN MIXER PVD BRUSHED NICKEL

JTV121PBN

Basin mixer with ultra thin pin lever handle
 Brushed nickel finish
 Durable brass body with 25mm ceramic disc
 Matching showers and accessories available
 Simple, secure fixing system
 WELS 6 Star, 4.5L/min T37931

RRP (exc. GST)
 \$300.00

RRP (inc. GST)
 \$330.00

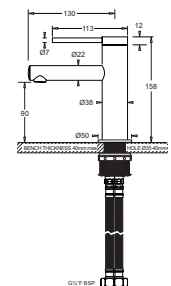

VENEZIA BASIN MIXER PVD BRUSHED BRASS

JTV121PBB

Basin mixer with ultra thin pin lever handle
 Brushed brass finish
 Durable brass body with 25mm ceramic disc
 Matching showers and accessories available
 Simple, secure fixing system
 WELS 6 Star, 4.5L/min T37931

RRP (exc. GST)
 \$300.00

RRP (inc. GST)
 \$330.00

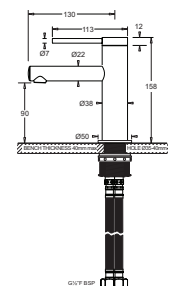

TAPWARE

VENEZIA EXTENDED BASIN MIXER CHROME

JTV223CH **RRP (exc. GST)** \$288.00 **RRP (inc. GST)** \$316.80

Extended height basin mixer with ultra thin pin lever handle
 Chrome finish
 Durable brass body with 25mm ceramic disc
 Matching showers and accessories available
 Simple, secure fixing system
 WELS 6 Star, 4.5L/min T38509

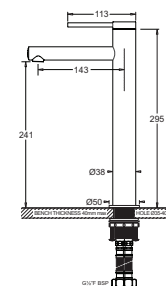

VENEZIA EXTENDED BASIN MIXER MATTE BLACK

JTV223EMB **RRP (exc. GST)** \$330.00 **RRP (inc. GST)** \$363.00

Extended height basin mixer with ultra thin pin lever handle
 Matte black finish
 Durable brass body with 25mm ceramic disc
 Matching showers and accessories available
 Simple, secure fixing system
 WELS 6 Star, 4.5L/min T38509

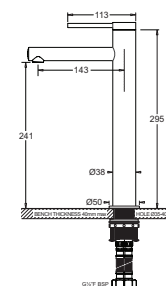

VENEZIA EXTENDED BASIN MIXER GUN METAL

JTV223EGM **RRP (exc. GST)** \$397.00 **RRP (inc. GST)** \$436.70

Extended height basin mixer with ultra thin pin lever handle
 Gun metal finish
 Durable brass body with 25mm ceramic disc
 Matching showers and accessories available
 Simple, secure fixing system
 WELS 6 Star, 4.5L/min T38509

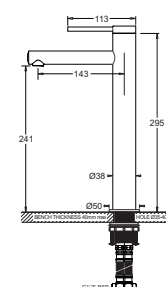

VENEZIA EXTENDED BASIN MIXER PVD BRUSHED NICKEL

JTV223PBN **RRP (exc. GST)** \$397.00 **RRP (inc. GST)** \$436.70

Extended height basin mixer with ultra thin pin lever handle
 Brushed nickel finish
 Durable brass body with 25mm ceramic disc
 Matching showers and accessories available
 Simple, secure fixing system
 WELS 6 Star, 4.5L/min T38509

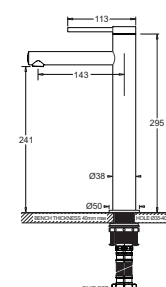

VENEZIA EXTENDED BASIN MIXER PVD BRUSHED BRASS

JTV223PBB **RRP (exc. GST)** \$397.00 **RRP (inc. GST)** \$436.70

Extended height basin mixer with ultra thin pin lever handle
 Brushed brass finish
 Durable brass body with 25mm ceramic disc
 Matching showers and accessories available
 Simple, secure fixing system
 WELS 6 Star, 4.5L/min T38509

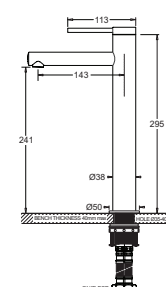

TAPWARE

VENEZIA SHOWER MIXER CHROME

JTV705CH **RRP (exc. GST)**
\$158.00

Wall mounted shower mixer with ultra thin pin lever handle
Chrome finish
Durable brass body with 25mm ceramic disc
Matching showers and accessories available
Simple, secure fixing system

RRP (inc. GST)
\$173.80

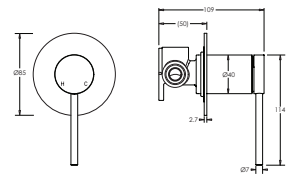

VENEZIA SHOWER MIXER MATTE BLACK

JTV705EMB **RRP (exc. GST)**
\$182.00

Wall mounted shower mixer with ultra thin pin lever handle
Matte black finish
Durable brass body with 25mm ceramic disc
Matching showers and accessories available
Simple, secure fixing system

RRP (inc. GST)
\$200.20

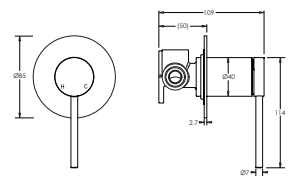

VENEZIA SHOWER MIXER GUN METAL

JTV705EGM **RRP (exc. GST)**
\$217.00

Wall mounted shower mixer with ultra thin pin lever handle
Gun metal finish
Durable brass body with 25mm ceramic disc
Matching showers and accessories available
Simple, secure fixing system

RRP (inc. GST)
\$238.70

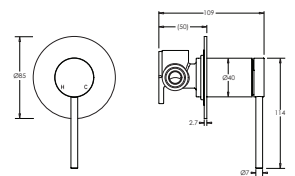

VENEZIA SHOWER MIXER PVD BRUSHED NICKEL

JTV705PBN **RRP (exc. GST)**
\$217.00

Wall mounted shower mixer with ultra thin pin lever handle
Brushed nickel finish
Durable brass body with 25mm ceramic disc
Matching showers and accessories available
Simple, secure fixing system

RRP (inc. GST)
\$238.70

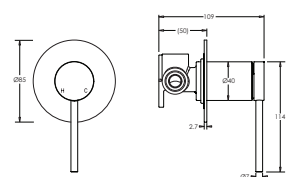

VENEZIA SHOWER MIXER PVD BRUSHED BRASS

JTV705PBB **RRP (exc. GST)**
\$217.00

Wall mounted shower mixer with ultra thin pin lever handle
Brushed brass finish
Durable brass body with 25mm ceramic disc
Matching showers and accessories available
Simple, secure fixing system

RRP (inc. GST)
\$238.70

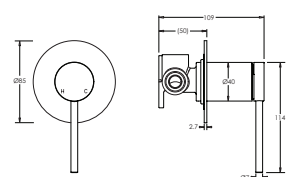

TAPWARE

VENEZIA SHOWER MIXER WITH DIVERTER CHROME

JTV605CH

RRP (exc. GST)
\$324.00

RRP (inc. GST)
\$356.40

Wall mounted pin lever shower mixer with diverter
Chrome finish
Durable brass body with 25mm ceramic disc
Matching showers and accessories available
Simple, secure fixing system

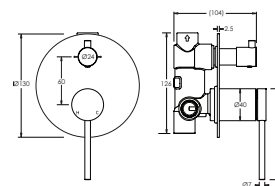

VENEZIA SHOWER MIXER WITH DIVERTER MATTE BLACK

JTV605EMB

RRP (exc. GST)
\$372.00

RRP (inc. GST)
\$409.20

Wall mounted pin lever shower mixer with diverter
Matte black finish
Durable brass body with 25mm ceramic disc
Matching showers and accessories available
Simple, secure fixing system

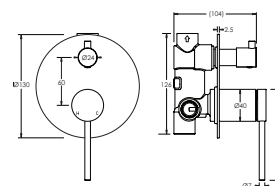

VENEZIA SHOWER MIXER WITH DIVERTER GUN METAL

JTV605EGM

RRP (exc. GST)
\$447.00

RRP (inc. GST)
\$491.70

Wall mounted pin lever shower mixer with diverter
Gun metal finish
Durable brass body with 25mm ceramic disc
Matching showers and accessories available
Simple, secure fixing system

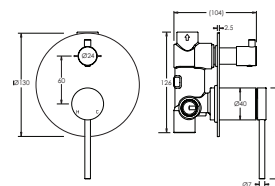

VENEZIA SHOWER MIXER WITH DIVERTER PVD BRUSHED NICKEL

JTV605PBN

RRP (exc. GST)
\$447.00

RRP (inc. GST)
\$491.70

Wall mounted pin lever shower mixer with diverter
Brushed nickel finish
Durable brass body with 25mm ceramic disc
Matching showers and accessories available
Simple, secure fixing system

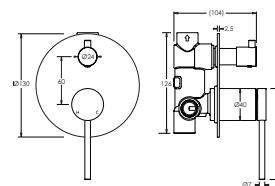

VENEZIA SHOWER MIXER WITH DIVERTER PVD BRUSHED BRASS

JTV605PBB

RRP (exc. GST)
\$447.00

RRP (inc. GST)
\$491.70

Wall mounted pin lever shower mixer with diverter
Brushed brass finish
Durable brass body with 25mm ceramic disc
Matching showers and accessories available
Simple, secure fixing system

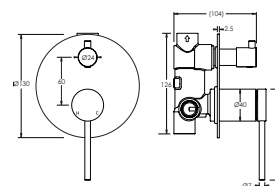

TAPWARE

VENEZIA FREESTANDING BATH FILLER CHROME

JTV14CH

Floor mounted bath filling spout
 Chrome finish
 Suitable for island bath installations
 Matching showers and accessories available
 Simple, secure fixing system

RRP (exc. GST)
 \$1,038.00

RRP (inc. GST)
 \$1,141.80

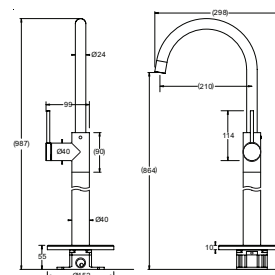

VENEZIA FREESTANDING BATH FILLER MATTE BLACK

JTV14EMB

Floor mounted bath filling spout
 Matte black finish
 Suitable for island bath installations
 Matching showers and accessories available
 Simple, secure fixing system

RRP (exc. GST)
 \$1,194.00

RRP (inc. GST)
 \$1,313.40

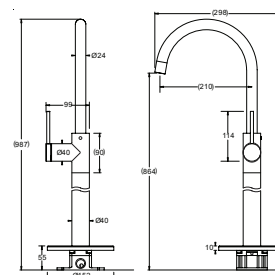

VENEZIA FREESTANDING BATH FILLER GUN METAL

JTV14EGM

Floor mounted bath filling spout
 Gun metal finish
 Suitable for island bath installations
 Matching showers and accessories available
 Simple, secure fixing system

RRP (exc. GST)
 \$1,432.00

RRP (inc. GST)
 \$1,575.20

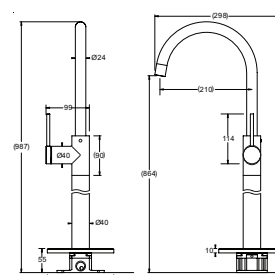

VENEZIA FREESTANDING BATH FILLER PVD BRUSHED NICKEL

JTV14PBN

Floor mounted bath filling spout
 Brushed nickel finish
 Suitable for island bath installations
 Matching showers and accessories available
 Simple, secure fixing system

RRP (exc. GST)
 \$1,432.00

RRP (inc. GST)
 \$1,575.20

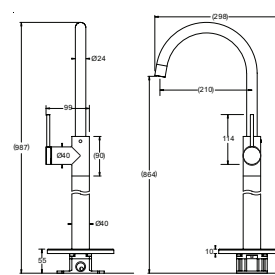

VENEZIA FREESTANDING BATH FILLER PVD BRUSHED BRASS

JTV14PBB

Floor mounted bath filling spout
 Brushed brass finish
 Suitable for island bath installations
 Matching showers and accessories available
 Simple, secure fixing system

RRP (exc. GST)
 \$1,432.00

RRP (inc. GST)
 \$1,575.20

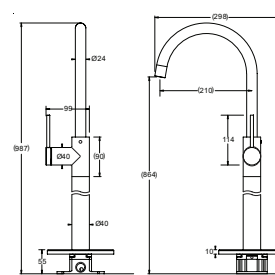

TAPWARE

VENEZIA BATH SPOUT CHROME

JTV02CH

Wall mounted bath spout
 Chrome finish
 Durable chromed brass construction with aerator
 Matching showers and accessories available
 Simple, secure fixing system

RRP (exc. GST)
 \$121.00

RRP (inc. GST)
 \$133.10

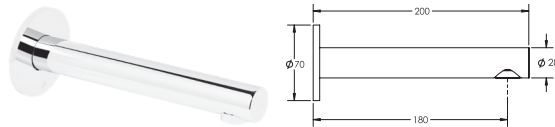

VENEZIA BATH SPOUT MATTE BLACK

JTV02EMB

Wall mounted bath spout
 Matte black finish
 Durable chromed brass construction with aerator
 Matching showers and accessories available
 Simple, secure fixing system

RRP (exc. GST)
 \$140.00

RRP (inc. GST)
 \$154.00

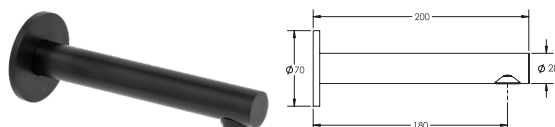

VENEZIA BATH SPOUT GUN METAL

JTV02EGM

Wall mounted bath spout
 Gun metal finish
 Durable chromed brass construction with aerator
 Matching showers and accessories available
 Simple, secure fixing system

RRP (exc. GST)
 \$167.00

RRP (inc. GST)
 \$183.70

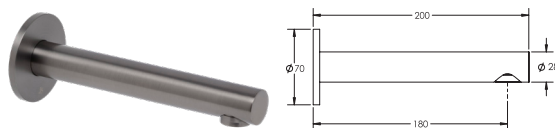

VENEZIA BATH SPOUT PVD BRUSHED NICKEL

JTV02PBN

Wall mounted bath spout
 Brushed nickel finish
 Durable chromed brass construction with aerator
 Matching showers and accessories available
 Simple, secure fixing system

RRP (exc. GST)
 \$167.00

RRP (inc. GST)
 \$183.70

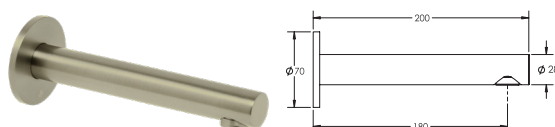

VENEZIA BATH SPOUT PVD BRUSHED BRASS

JTV02PBB

Wall mounted bath spout
 Brushed brass finish
 Durable chromed brass construction with aerator
 Matching showers and accessories available
 Simple, secure fixing system

RRP (exc. GST)
 \$167.00

RRP (inc. GST)
 \$183.70

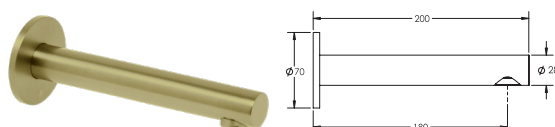

TAPWARE

VENEZIA SWIVEL BATH SPOUT CHROME

JTV08CH **RRP (exc. GST)** \$121.00 **RRP (inc. GST)** \$133.10

Wall mounted swivel bath spout
 Chrome finish
 Durable chromed brass construction with aerator
 Matching showers and accessories available
 Simple, secure fixing system

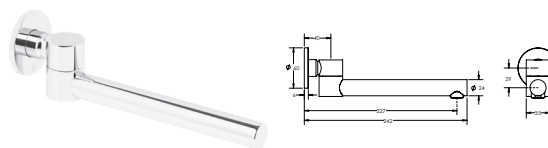

VENEZIA SWIVEL BATH SPOUT MATTE BLACK

JTV08EMB **RRP (exc. GST)** \$140.00 **RRP (inc. GST)** \$154.00

Wall mounted swivel bath spout
 Matte black finish
 Durable chromed brass construction with aerator
 Matching showers and accessories available
 Simple, secure fixing system

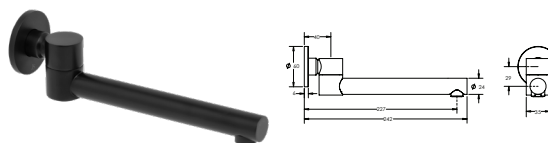

VENEZIA SWIVEL BATH SPOUT GUN METAL

JTV08EGM **RRP (exc. GST)** \$167.00 **RRP (inc. GST)** \$183.70

Wall mounted swivel bath spout
 Gun metal finish
 Durable chromed brass construction with aerator
 Matching showers and accessories available
 Simple, secure fixing system

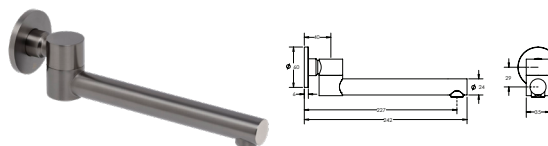

VENEZIA SWIVEL BATH SPOUT PVD BRUSHED NICKEL

JTV08PBN **RRP (exc. GST)** \$167.00 **RRP (inc. GST)** \$183.70

Wall mounted swivel bath spout
 Brushed nickel finish
 Durable chromed brass construction with aerator
 Matching showers and accessories available
 Simple, secure fixing system

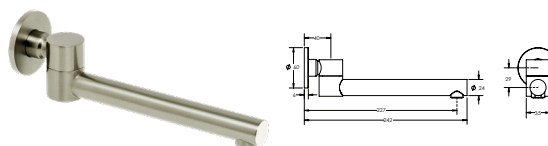

VENEZIA SWIVEL BATH SPOUT PVD BRUSHED BRASS

JTV08PBB **RRP (exc. GST)** \$167.00 **RRP (inc. GST)** \$183.70

Wall mounted swivel bath spout
 Brushed brass finish
 Durable chromed brass construction with aerator
 Matching showers and accessories available
 Simple, secure fixing system

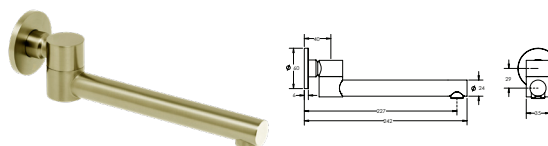

KITCHEN MIXER

VENEZIA GOOSENECK SINK MIXER CHROME

JTV403CH

Curved spout sink mixer with pin lever handle
 Chrome finish
 Durable brass body with 35mm ceramic disc
 Simple, secure fixing system
 WELS 5 Star, 5.5L/min T38515

RRP (exc. GST)
 \$336.00

RRP (inc. GST)
 \$369.60

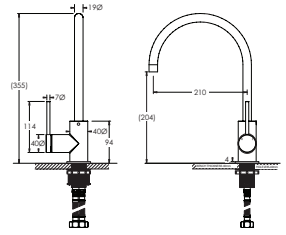

VENEZIA GOOSENECK SINK MIXER MATTE BLACK

JTV403EMB

Curved spout sink mixer with pin lever handle
 Matte black finish
 Durable brass body with 35mm ceramic disc
 Simple, secure fixing system
 WELS 5 Star, 5.5L/min T38515

RRP (exc. GST)
 \$388.00

RRP (inc. GST)
 \$426.80

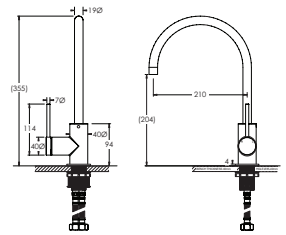

VENEZIA GOOSENECK SINK MIXER GUN METAL

JTV403EGM

Curved spout sink mixer with pin lever handle
 Gun metal finish
 Durable brass body with 35mm ceramic disc
 Simple, secure fixing system
 WELS 5 Star, 5.5L/min T38515

RRP (exc. GST)
 \$464.00

RRP (inc. GST)
 \$510.40

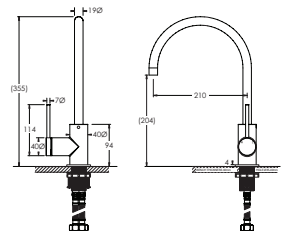

VENEZIA GOOSENECK SINK MIXER PVD BRUSHED NICKEL

JTV403PBN

Curved spout sink mixer with pin lever handle
 Brushed nickel finish
 Durable brass body with 35mm ceramic disc
 Simple, secure fixing system
 WELS 5 Star, 5.5L/min T38515

RRP (exc. GST)
 \$464.00

RRP (inc. GST)
 \$510.40

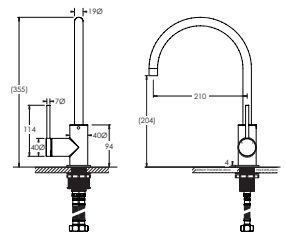

VENEZIA GOOSENECK SINK MIXER PVD BRUSHED BRASS

JTV403PBB

Curved spout sink mixer with pin lever handle
 Brushed brass finish
 Durable brass body with 35mm ceramic disc
 Simple, secure fixing system
 WELS 5 Star, 5.5L/min T38515

RRP (exc. GST)
 \$464.00

RRP (inc. GST)
 \$510.40

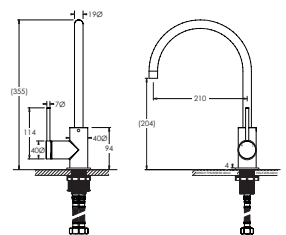

VENEZIA CARE EXTENDED LEVER BASIN MIXER

VENEZIA CARE EXTENDED LEVER BASIN MIXER CHROME

JTV121CHL **RRP (exc. GST)** \$289.00 **RRP (inc. GST)** \$317.90

Basin mixer with ultra thin pin lever handle
Chrome finish
Durable DZR construction with 25mm ceramic cartridge
Simple, secure fixing system
Suitable for special needs applications (AS1428.1 compliant) for people with disability
WELS 6 Star, 4.5L/min T37931

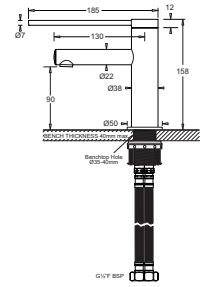

VENEZIA CARE EXTENDED LEVER BASIN MIXER MATTE BLACK

JTV121EMBL **RRP (exc. GST)** \$342.00 **RRP (inc. GST)** \$376.20

Basin mixer with ultra thin pin lever handle
Matte black finish
Durable DZR construction with 25mm ceramic cartridge
Simple, secure fixing system
Suitable for special needs applications (AS1428.1 compliant) for people with disability
WELS 6 Star, 4.5L/min T37931

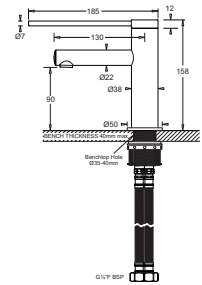

SHOWERS

VENEZIA RAIL SHOWER CHROME

JTV19CH

Rail shower system
 Chrome finish
 Slim, lightweight shower wand with 1.5mm hose
 Concealed water inlet
 Simple, secure fixing system
 WELS 3 Star, 9L/min S16877

RRP (exc. GST)
 \$267.00

RRP (inc. GST)
 \$293.70

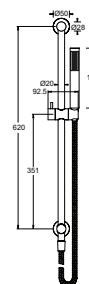

VENEZIA RAIL SHOWER MATTE BLACK

JTV19EMB

Rail shower system
 Matte black finish
 Slim, lightweight shower wand with 1.5mm hose
 Concealed water inlet
 Simple, secure fixing system
 WELS 3 Star, 9L/min S16877

RRP (exc. GST)
 \$308.00

RRP (inc. GST)
 \$338.80

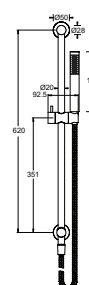

VENEZIA RAIL SHOWER GUN METAL

JTV19EGM

Rail shower system
 Gun metal finish
 Slim, lightweight shower wand with 1.5mm hose
 Concealed water inlet
 Simple, secure fixing system
 WELS 3 Star, 9L/min S16877

RRP (exc. GST)
 \$370.00

RRP (inc. GST)
 \$407.00

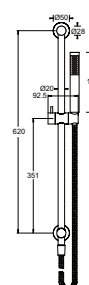

VENEZIA RAIL SHOWER PVD BRUSHED NICKEL

JTV19PBN

Rail shower system
 Brushed nickel finish
 Slim, lightweight shower wand with 1.5mm hose
 Concealed water inlet
 Simple, secure fixing system
 WELS 3 Star, 9L/min S16877

RRP (exc. GST)
 \$370.00

RRP (inc. GST)
 \$407.00

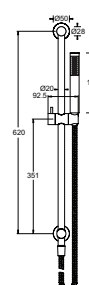

VENEZIA RAIL SHOWER PVD BRUSHED BRASS

JTV19PBB

Rail shower system
 Brushed brass finish
 Slim, lightweight shower wand with 1.5mm hose
 Concealed water inlet
 Simple, secure fixing system
 WELS 3 Star, 9L/min S16877

RRP (exc. GST)
 \$370.00

RRP (inc. GST)
 \$407.00

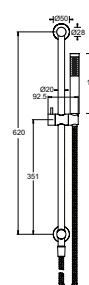

SHOWERS

VENEZIA HAND SHOWER ON WOB CHROME

JTV18CH

Shower wand
 Chrome finish
 Slim, lightweight shower wand with 1.5mm hose
 Simple, secure fixing system
 WELS 3 Star, 9L/min S15873

RRP (exc. GST)
 \$215.00

RRP (inc. GST)
 \$236.50

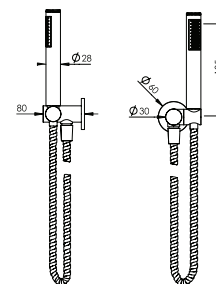

VENEZIA HAND SHOWER ON WOB MATTE BLACK

JTV18EMB

Shower wand
 Matte black finish
 Slim, lightweight shower wand with 1.5mm hose
 Simple, secure fixing system
 WELS 3 Star, 9L/min S15873

RRP (exc. GST)
 \$248.00

RRP (inc. GST)
 \$272.80

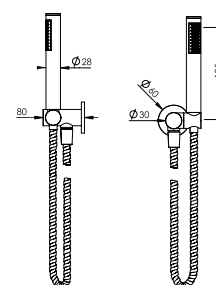

VENEZIA HAND SHOWER ON WOB GUN METAL

JTV18EGM

Shower wand
 Gun metal finish
 Slim, lightweight shower wand with 1.5mm hose
 Simple, secure fixing system
 WELS 3 Star, 9L/min S15873

RRP (exc. GST)
 \$298.00

RRP (inc. GST)
 \$327.80

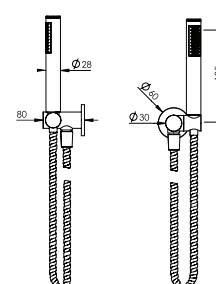

VENEZIA HAND SHOWER ON WOB PVD BRUSHED NICKEL

JTV18PBN

Shower wand
 Brushed nickel finish
 Slim, lightweight shower wand with 1.5mm hose
 Simple, secure fixing system
 WELS 3 Star, 9L/min S15873

RRP (exc. GST)
 \$298.00

RRP (inc. GST)
 \$327.80

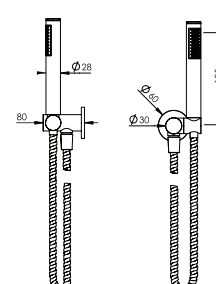

VENEZIA HAND SHOWER ON WOB PVD BRUSHED BRASS

JTV18PBB

Shower wand
 Brushed brass finish
 Slim, lightweight shower wand with 1.5mm hose
 Simple, secure fixing system
 WELS 3 Star, 9L/min S15873

RRP (exc. GST)
 \$298.00

RRP (inc. GST)
 \$327.80

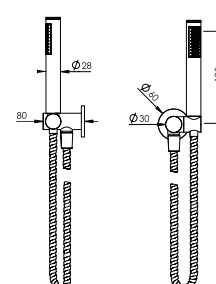

SHOWERS

VENEZIA TWIN SHOWER CHROME

JTV21CH **RRP (exc. GST)** \$488.00 **RRP (inc. GST)** \$536.80

Combo shower - rail mounted rose with hand wand
 Chrome finish
 200mm fixed shower rose, slim shower wand with 1.5mm hose
 Pin lever rose/hand wand diverter activation
 Simple, secure fixing system with concealed water inlet
 WELS 3 Star, 9L/min S16052

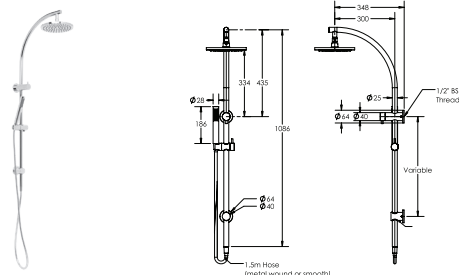

VENEZIA TWIN SHOWER MATTE BLACK

JTV21EMB **RRP (exc. GST)** \$584.00 **RRP (inc. GST)** \$642.40

Combo shower - rail mounted rose with hand wand
 Matte black finish
 200mm fixed shower rose, slim shower wand with 1.5mm hose
 Pin lever rose/hand wand diverter activation
 Simple, secure fixing system with concealed water inlet
 WELS 3 Star, 9L/min S16052

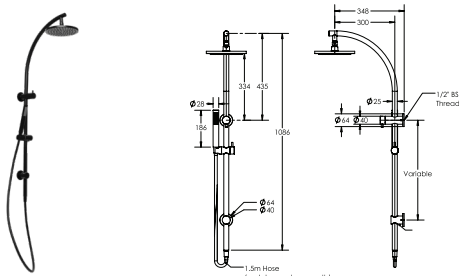

VENEZIA TWIN SHOWER GUN METAL

JTV21EGM **RRP (exc. GST)** \$703.00 **RRP (inc. GST)** \$773.30

Combo shower - rail mounted rose with hand wand
 Gun metal finish
 200mm fixed shower rose, slim shower wand with 1.5mm hose
 Pin lever rose/hand wand diverter activation
 Simple, secure fixing system with concealed water inlet
 WELS 3 Star, 9L/min S16052

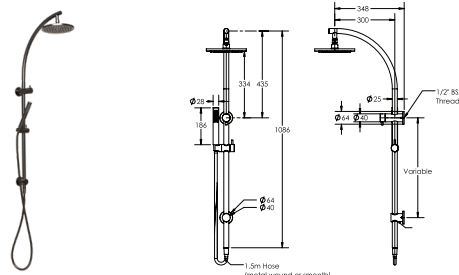

VENEZIA TWIN SHOWER PVD BRUSHED NICKEL

JTV21PBN **RRP (exc. GST)** \$703.00 **RRP (inc. GST)** \$773.30

Combo shower - rail mounted rose with hand wand
 Brushed nickel finish
 200mm fixed shower rose, slim shower wand with 1.5mm hose
 Pin lever rose/hand wand diverter activation
 Simple, secure fixing system with concealed water inlet
 WELS 3 Star, 9L/min S16052

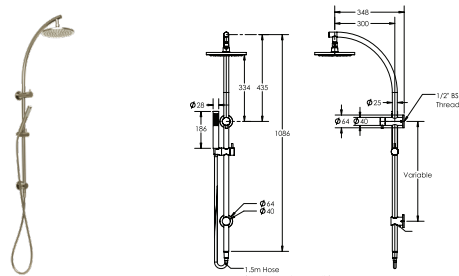

VENEZIA TWIN SHOWER PVD BRUSHED BRASS

JTV21PBB **RRP (exc. GST)** \$703.00 **RRP (inc. GST)** \$773.30

Combo shower - rail mounted rose with hand wand
 Brushed brass finish
 200mm fixed shower rose, slim shower wand with 1.5mm hose
 Pin lever rose/hand wand diverter activation
 Simple, secure fixing system with concealed water inlet
 WELS 3 Star, 9L/min S16052

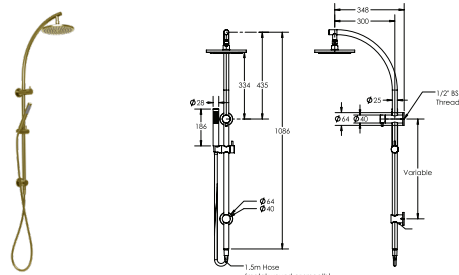

SHOWERS

VENEZIA SHORT TWIN SHOWER CHROME

JTV20CH **RRP (exc. GST)** \$426.00 **RRP (inc. GST)** \$468.60

Combo shower - fixed rose and separate hand wand
 Chrome finish
 200mm fixed shower rose, slim shower wand with 1.5mm hose
 Pin lever rose/hand wand diverter activation
 Simple, secure fixing system with concealed water inlet
 WELS 3 Star, 9L/min S16066

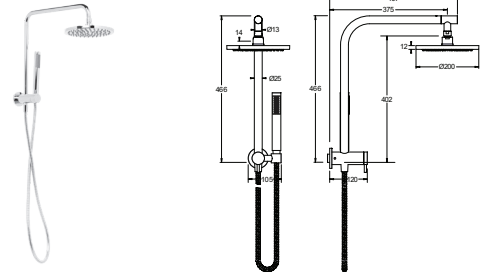

VENEZIA SHORT TWIN SHOWER MATTE BLACK

JTV20EMB **RRP (exc. GST)** \$501.00 **RRP (inc. GST)** \$551.10

Combo shower - fixed rose and separate hand wand
 Matte black finish
 200mm fixed shower rose, slim shower wand with 1.5mm hose
 Pin lever rose/hand wand diverter activation
 Simple, secure fixing system with concealed water inlet
 WELS 3 Star, 9L/min S16066

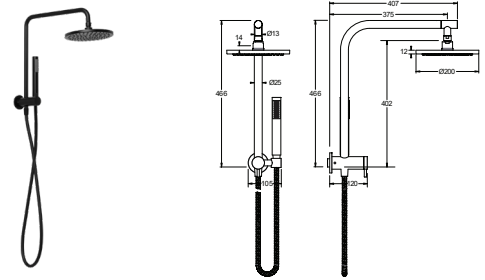

VENEZIA SHORT TWIN SHOWER GUN METAL

JTV20EGM **RRP (exc. GST)** \$600.00 **RRP (inc. GST)** \$660.00

Combo shower - fixed rose and separate hand wand
 Gun metal finish
 200mm fixed shower rose, slim shower wand with 1.5mm hose
 Pin lever rose/hand wand diverter activation
 Simple, secure fixing system with concealed water inlet
 WELS 3 Star, 9L/min S16066

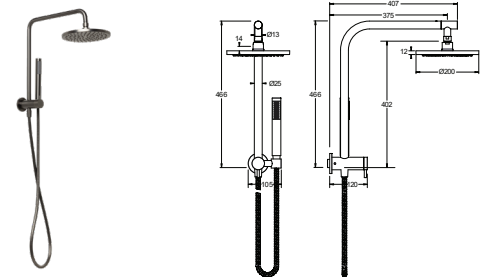

VENEZIA SHORT TWIN SHOWER PVD BRUSHED NICKEL

JTV20PBN **RRP (exc. GST)** \$600.00 **RRP (inc. GST)** \$660.00

Combo shower - fixed rose and separate hand wand
 Brushed nickel finish
 200mm fixed shower rose, slim shower wand with 1.5mm hose
 Pin lever rose/hand wand diverter activation
 Simple, secure fixing system with concealed water inlet
 WELS 3 Star, 9L/min S16066

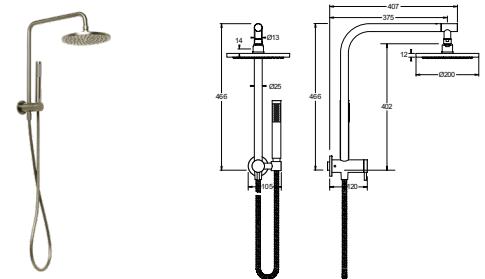

VENEZIA SHORT TWIN SHOWER PVD BRUSHED BRASS

JTV20PBB **RRP (exc. GST)** \$600.00 **RRP (inc. GST)** \$660.00

Combo shower - fixed rose and separate hand wand
 Brushed brass finish
 200mm fixed shower rose, slim shower wand with 1.5mm hose
 Pin lever rose/hand wand diverter activation
 Simple, secure fixing system with concealed water inlet
 WELS 3 Star, 9L/min S16066

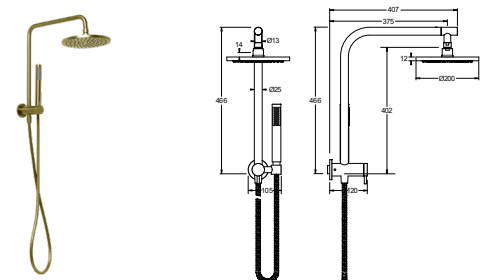

SHOWERS

VENEZIA OVERHEAD RAIN SHOWER WITH 300MM CEILING ARM CHROME

JTV12CH.JTV07CH

RRP (exc. GST) \$281.00 **RRP (inc. GST) \$309.10**

Rain shower head with 300mm ceiling arm
 Chrome finish
 Comfort shower - 105 silicone water jet nozzles
 Matching showers and accessories available
 Simple installation with ½" BSP connections
 WELS 3 Star, 9L/min S15880

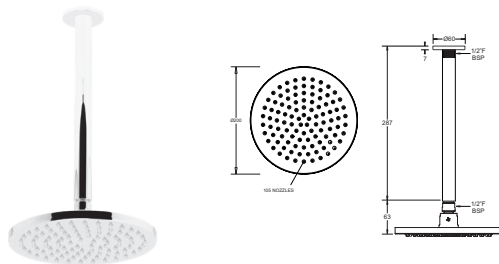

VENEZIA OVERHEAD RAIN SHOWER WITH 300MM CEILING ARM MATTE BLACK

JTV12EMB.JTV07EMB

RRP (exc. GST) \$322.00 **RRP (inc. GST) \$354.20**

Rain shower head with 300mm ceiling arm
 Matte black finish
 Comfort shower - 105 silicone water jet nozzles
 Matching showers and accessories available
 Simple installation with ½" BSP connections
 WELS 3 Star, 9L/min S15880

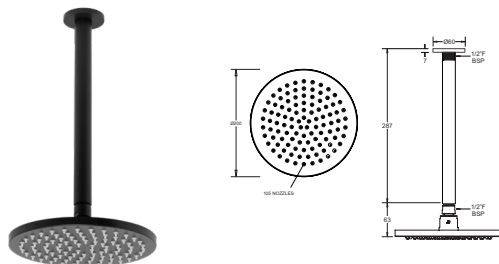

VENEZIA OVERHEAD RAIN SHOWER WITH 300MM CEILING ARM GUN METAL

JTV12EGM.JTV07EGM

RRP (exc. GST) \$386.00 **RRP (inc. GST) \$424.60**

Rain shower head with 300mm ceiling arm
 Gun metal finish
 Comfort shower - 105 silicone water jet nozzles
 Matching showers and accessories available
 Simple installation with ½" BSP connections
 WELS 3 Star, 9L/min S15880

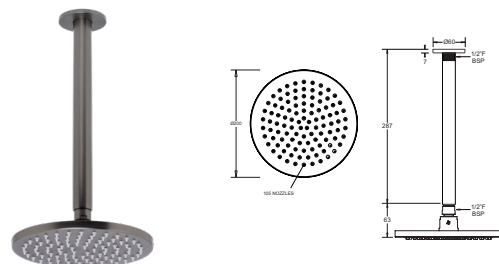

VENEZIA OVERHEAD RAIN SHOWER WITH 300MM CEILING ARM PVD BRUSHED NICKEL

JTV12PBN.JTV07PBN

RRP (exc. GST) \$378.00 **RRP (inc. GST) \$415.80**

Rain shower head with 300mm ceiling arm
 Brushed nickel finish
 Comfort shower - 105 silicone water jet nozzles
 Matching showers and accessories available
 Simple installation with ½" BSP connections
 WELS 3 Star, 9L/min S15880

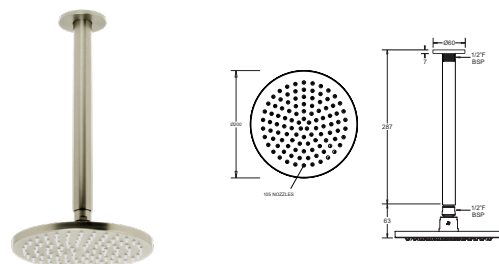

VENEZIA OVERHEAD RAIN SHOWER WITH 300MM CEILING ARM PVD BRUSHED BRASS

JTV12PBB.JTV07PBB

RRP (exc. GST) \$378.00 **RRP (inc. GST) \$415.80**

Rain shower head with 300mm ceiling arm
 Brushed brass finish
 Comfort shower - 105 silicone water jet nozzles
 Matching showers and accessories available
 Simple installation with ½" BSP connections
 WELS 3 Star, 9L/min S15880

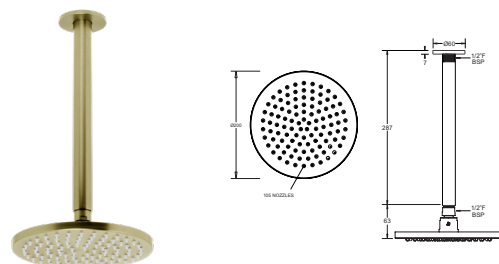

SHOWERS

VENEZIA OVERHEAD RAIN SHOWER WITH 300MM WALL ARM CHROME

JTV12CH.JTV09CH

RRP (exc. GST) \$281.00 **RRP (inc. GST) \$309.10**

Rain shower head with 300mm ceiling arm
 Chrome finish
 Comfort shower - 105 silicone water jet nozzles
 Matching showers and accessories available
 Simple installation with ½" BSP connections
 WELS 3 Star, 8.5L/min S15889

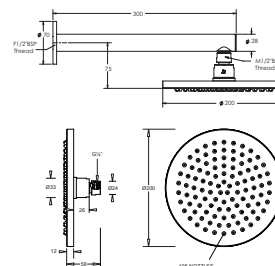

VENEZIA OVERHEAD RAIN SHOWER WITH 300MM WALL ARM MATTE BLACK

JTV12EMB.JTV09EMB

RRP (exc. GST) \$323.00 **RRP (inc. GST) \$355.30**

Rain shower head with 300mm ceiling arm
 Matte black finish
 Comfort shower - 105 silicone water jet nozzles
 Matching showers and accessories available
 Simple installation with ½" BSP connections
 WELS 3 Star, 8.5L/min S15889

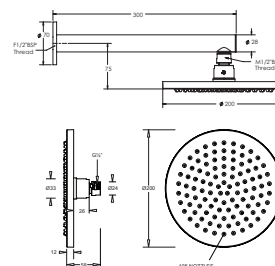

VENEZIA OVERHEAD RAIN SHOWER WITH 300MM WALL ARM GUN METAL

JTV12EGM.JTV09EGM

RRP (exc. GST) \$388.00 **RRP (inc. GST) \$426.80**

Rain shower head with 300mm ceiling arm
 Gun metal finish
 Comfort shower - 105 silicone water jet nozzles
 Matching showers and accessories available
 Simple installation with ½" BSP connections
 WELS 3 Star, 8.5L/min S15889

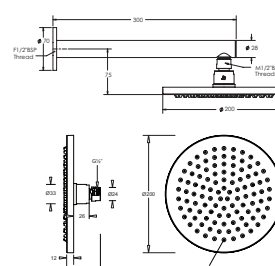

VENEZIA OVERHEAD RAIN SHOWER WITH 300MM WALL ARM PVD BRUSHED NICKEL

JTV12PBN.JTV09PBN

RRP (exc. GST) \$380.00 **RRP (inc. GST) \$418.00**

Rain shower head with 300mm ceiling arm
 Brushed nickel finish
 Comfort shower - 105 silicone water jet nozzles
 Matching showers and accessories available
 Simple installation with ½" BSP connections
 WELS 3 Star, 8.5L/min S15889

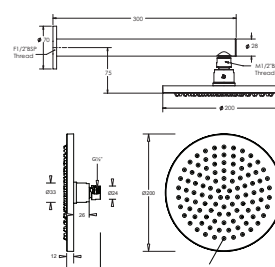

VENEZIA OVERHEAD RAIN SHOWER WITH 300MM WALL ARM PVD BRUSHED BRASS

JTV12PBB.JTV09PBB

RRP (exc. GST) \$380.00 **RRP (inc. GST) \$418.00**

Rain shower head with 300mm ceiling arm
 Brushed brass finish
 Comfort shower - 105 silicone water jet nozzles
 Matching showers and accessories available
 Simple installation with ½" BSP connections
 WELS 3 Star, 8.5L/min S15889

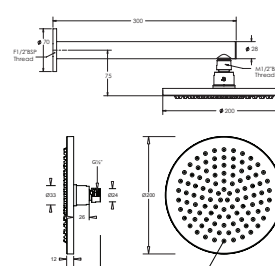

ACCESSORIES

VENEZIA TOILET ROLL HOLDER CHROME

JACV111CH

Single bar toilet roll holder
 Chrome finish
 Durable brass construction
 Simple, secure fixing
 Other matching Venezia design accessories available

RRP (exc. GST)
 \$39.00

RRP (inc. GST)
 \$42.90

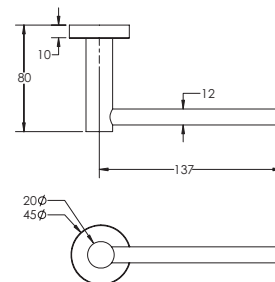

VENEZIA TOILET ROLL HOLDER MATTE BLACK

JACV111EMB

Single bar toilet roll holder
 Matte black finish
 Durable brass construction
 Simple, secure fixing
 Other matching Venezia design accessories available

RRP (exc. GST)
 \$44.00

RRP (inc. GST)
 \$48.40

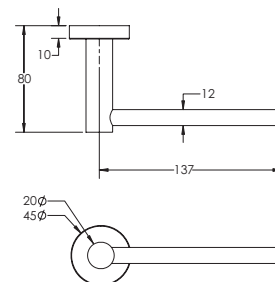

VENEZIA TOILET ROLL HOLDER GUN METAL

JACV111EGM

Single bar toilet roll holder
 Gun metal finish
 Durable brass construction
 Simple, secure fixing
 Other matching Venezia design accessories available

RRP (exc. GST)
 \$56.00

RRP (inc. GST)
 \$61.60

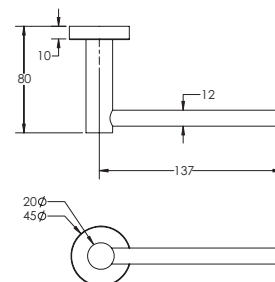

VENEZIA TOILET ROLL HOLDER PVD BRUSHED NICKEL

JACV111PBN

Single bar toilet roll holder
 Brushed nickel finish
 Durable brass construction
 Simple, secure fixing
 Other matching Venezia design accessories available

RRP (exc. GST)
 \$56.00

RRP (inc. GST)
 \$61.60

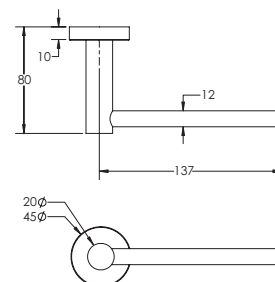

VENEZIA TOILET ROLL HOLDER PVD BRUSHED BRASS

JACV111PBB

Single bar toilet roll holder
 Brushed brass finish
 Durable brass construction
 Simple, secure fixing
 Other matching Venezia design accessories available

RRP (exc. GST)
 \$56.00

RRP (inc. GST)
 \$61.60

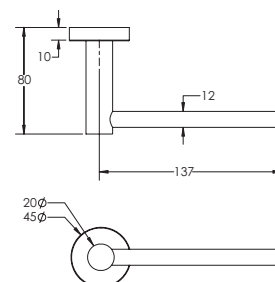

ACCESSORIES

VENEZIA TOWEL HOLDER CHROME

JACV112CH

Single bar towel holder
 Chrome finish
 Durable brass construction
 Simple, secure fixing
 Other matching Venezia design accessories available

RRP (exc. GST)
 \$51.00

RRP (inc. GST)
 \$56.10

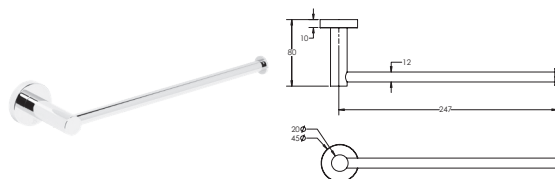

VENEZIA TOWEL HOLDER MATTE BLACK

JACV112EMB

Single bar towel holder
 Matte black finish
 Durable brass construction
 Simple, secure fixing
 Other matching Venezia design accessories available

RRP (exc. GST)
 \$64.00

RRP (inc. GST)
 \$70.40

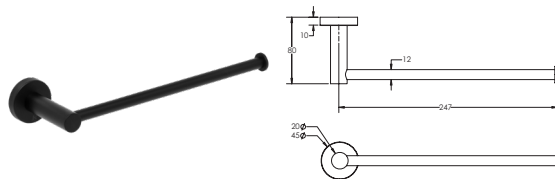

VENEZIA TOWEL HOLDER GUN METAL

JACV112EGM

Single bar towel holder
 Gun metal finish
 Durable brass construction
 Simple, secure fixing
 Other matching Venezia design accessories available

RRP (exc. GST)
 \$80.00

RRP (inc. GST)
 \$88.00

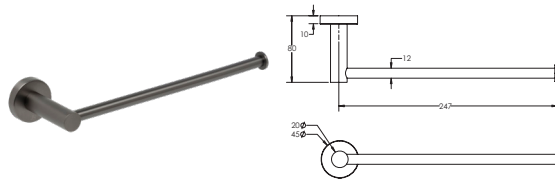

VENEZIA TOWEL HOLDER PVD BRUSHED NICKEL

JACV112PBN

Single bar towel holder
 Brushed nickel finish
 Durable brass construction
 Simple, secure fixing
 Other matching Venezia design accessories available

RRP (exc. GST)
 \$80.00

RRP (inc. GST)
 \$88.00

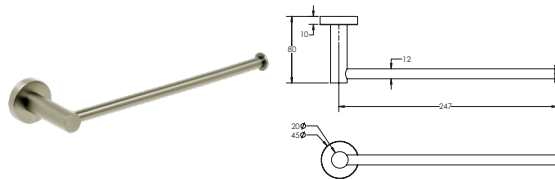

VENEZIA TOWEL HOLDER PVD BRUSHED BRASS

JACV112PBB

Single bar towel holder
 Brushed brass finish
 Durable brass construction
 Simple, secure fixing
 Other matching Venezia design accessories available

RRP (exc. GST)
 \$80.00

RRP (inc. GST)
 \$88.00

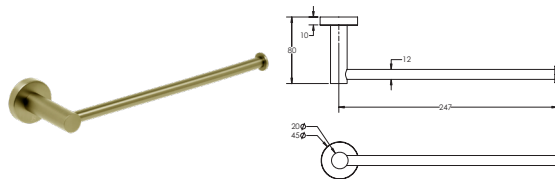

ACCESSORIES

VENEZIA SOAP DISH CHROME

JACV113CH

Wall mounted soap dish
 Chrome finish
 Durable brass construction
 Self draining
 Simple, secure fixing
 Other matching Venezia design accessories available

RRP (exc. GST)
 \$64.00

RRP (inc. GST)
 \$70.40

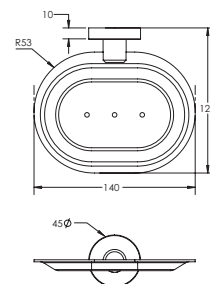

VENEZIA SOAP DISH MATTE BLACK

JACV113EMB

Wall mounted soap dish
 Matte black finish
 Durable brass construction
 Self draining
 Simple, secure fixing
 Other matching Venezia design accessories available

RRP (exc. GST)
 \$77.00

RRP (inc. GST)
 \$84.70

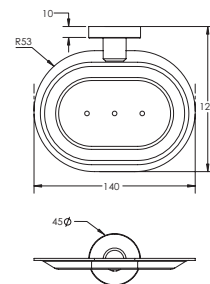

VENEZIA SOAP DISH GUN METAL

JACV113EGM

Wall mounted soap dish
 Gun metal finish
 Durable brass construction
 Self draining
 Simple, secure fixing
 Other matching Venezia design accessories available

RRP (exc. GST)
 \$96.00

RRP (inc. GST)
 \$105.60

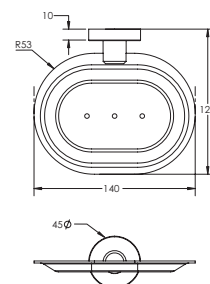

VENEZIA SOAP DISH PVD BRUSHED NICKEL

JACV113PBN

Wall mounted soap dish
 Brushed nickel finish
 Durable brass construction
 Self draining
 Simple, secure fixing
 Other matching Venezia design accessories available

RRP (exc. GST)
 \$96.00

RRP (inc. GST)
 \$105.60

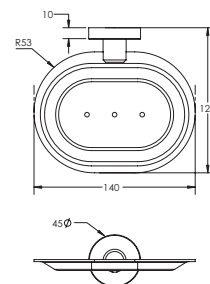

VENEZIA SOAP DISH PVD BRUSHED BRASS

JACV113PBB

Wall mounted soap dish
 Brushed brass finish
 Durable brass construction
 Self draining
 Simple, secure fixing
 Other matching Venezia design accessories available

RRP (exc. GST)
 \$96.00

RRP (inc. GST)
 \$105.60

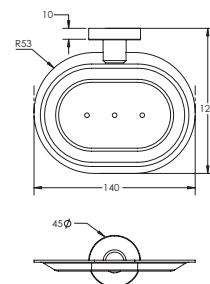

ACCESSORIES

VENEZIA TOWEL RING CHROME

JACV115CH

Towel ring (Ø177mm)
 Chrome finish
 Durable brass construction
 Simple, secure fixing
 Other matching Venezia design accessories available

RRP (exc. GST)
 \$46.00

RRP (inc. GST)
 \$50.60

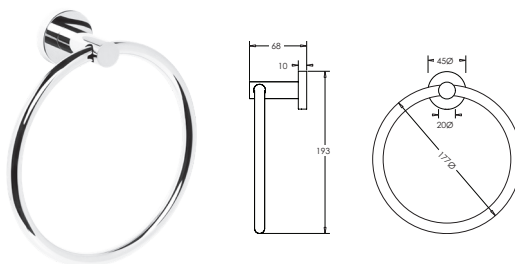

VENEZIA TOWEL RING MATTE BLACK

JACV115EMB

Towel ring (Ø177mm)
 Matte black finish
 Durable brass construction
 Simple, secure fixing
 Other matching Venezia design accessories available

RRP (exc. GST)
 \$82.00

RRP (inc. GST)
 \$90.20

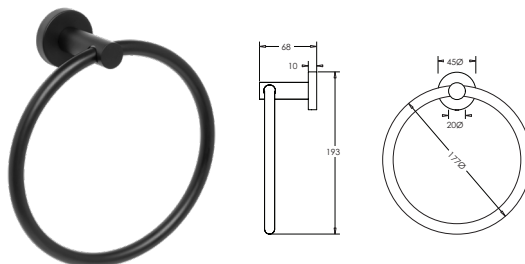

VENEZIA TOWEL RING GUN METAL

JACV115EGM

Towel ring (Ø177mm)
 Gun metal finish
 Durable brass construction
 Simple, secure fixing
 Other matching Venezia design accessories available

RRP (exc. GST)
 \$101.00

RRP (inc. GST)
 \$111.10

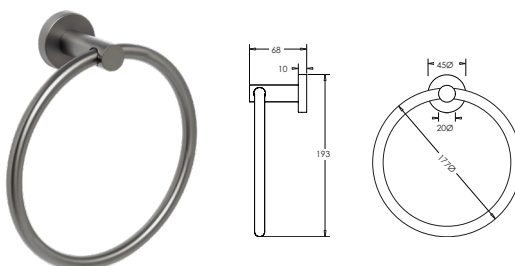

VENEZIA TOWEL RING PVD BRUSHED NICKEL

JACV115PBN

Towel ring (Ø177mm)
 Brushed nickel finish
 Durable brass construction
 Simple, secure fixing
 Other matching Venezia design accessories available

RRP (exc. GST)
 \$101.00

RRP (inc. GST)
 \$111.10

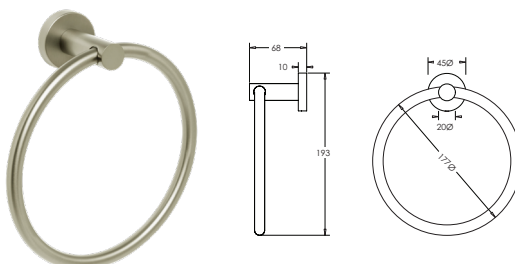

VENEZIA TOWEL RING PVD BRUSHED BRASS

JACV115PBB

Towel ring (Ø177mm)
 Brushed brass finish
 Durable brass construction
 Simple, secure fixing
 Other matching Venezia design accessories available

RRP (exc. GST)
 \$101.00

RRP (inc. GST)
 \$111.10

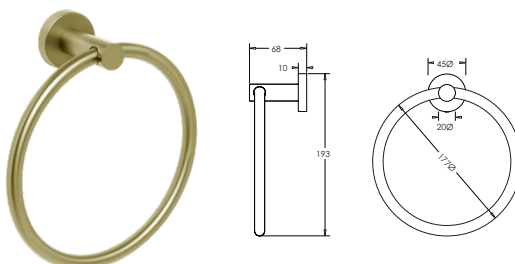

ACCESSORIES

VENEZIA METAL SHELF 450MM CHROME

JACV116CH **RRP (exc. GST)** \$259.00 **RRP (inc. GST)** \$284.90

Wall mounted metal shelf
 Chrome finish
 450x100mm shelf with self-draining soap recess
 Durable brass construction
 Simple, secure fixing
 Other matching Venezia design accessories available

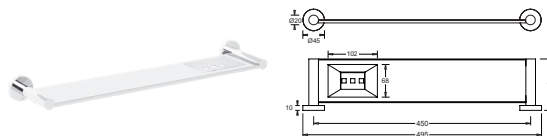

VENEZIA METAL SHELF 450MM MATTE BLACK

JACV116EMB **RRP (exc. GST)** \$380.00 **RRP (inc. GST)** \$418.00

Wall mounted metal shelf
 Matte black finish
 450x100mm shelf with self-draining soap recess
 Durable brass construction
 Simple, secure fixing
 Other matching Venezia design accessories available

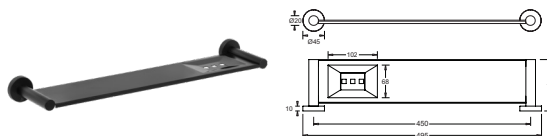

VENEZIA METAL SHELF 450MM GUN METAL

JACV116EGM **RRP (exc. GST)** \$429.00 **RRP (inc. GST)** \$471.90

Wall mounted metal shelf
 Gun metal finish
 450x100mm shelf with self-draining soap recess
 Durable brass construction
 Simple, secure fixing
 Other matching Venezia design accessories available

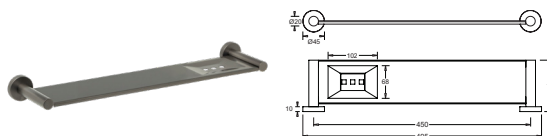

VENEZIA METAL SHELF 450MM PVD BRUSHED NICKEL

JACV116PBN **RRP (exc. GST)** \$429.00 **RRP (inc. GST)** \$471.90

Wall mounted metal shelf
 Brushed nickel finish
 450x100mm shelf with self-draining soap recess
 Durable brass construction
 Simple, secure fixing
 Other matching Venezia design accessories available

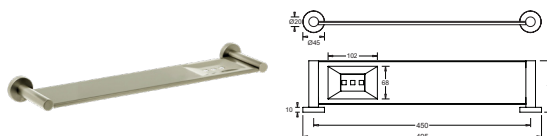

VENEZIA METAL SHELF 450MM PVD BRUSHED BRASS

JACV116PBB **RRP (exc. GST)** \$429.00 **RRP (inc. GST)** \$471.90

Wall mounted metal shelf
 Brushed brass finish
 450x100mm shelf with self-draining soap recess
 Durable brass construction
 Simple, secure fixing
 Other matching Venezia design accessories available

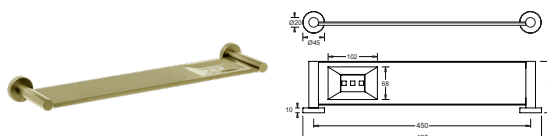

ACCESSORIES

VENEZIA ROBE HOOK CHROME

JACV222CH

Single robe hook
 Chrome finish
 Durable brass construction
 Simple, secure fixing
 Other matching Venezia design accessories available

RRP (exc. GST)
 \$36.00

RRP (inc. GST)
 \$39.60

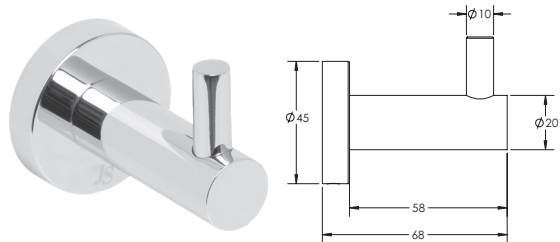

VENEZIA ROBE HOOK MATTE BLACK

JACV222EMB

Single robe hook
 Matte black finish
 Durable brass construction
 Simple, secure fixing
 Other matching Venezia design accessories available

RRP (exc. GST)
 \$42.00

RRP (inc. GST)
 \$46.20

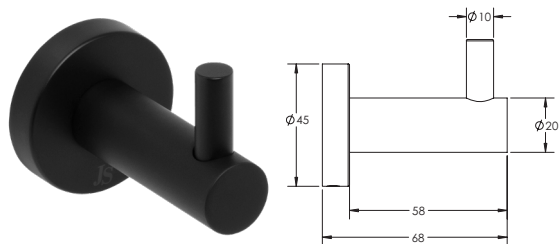

VENEZIA ROBE HOOK GUN METAL

JACV222EGM

Single robe hook
 Gun metal finish
 Durable brass construction
 Simple, secure fixing
 Other matching Venezia design accessories available

RRP (exc. GST)
 \$43.00

RRP (inc. GST)
 \$47.30

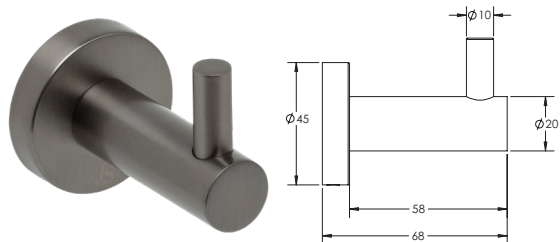

VENEZIA ROBE HOOK PVD BRUSHED NICKEL

JACV222PBN

Single robe hook
 Brushed nickel finish
 Durable brass construction
 Simple, secure fixing
 Other matching Venezia design accessories available

RRP (exc. GST)
 \$43.00

RRP (inc. GST)
 \$47.30

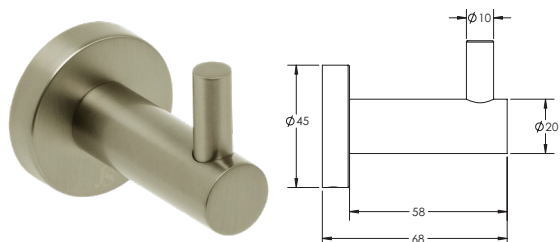

VENEZIA ROBE HOOK PVD BRUSHED BRASS

JACV222PBB

Single robe hook
 Brushed brass finish
 Durable brass construction
 Simple, secure fixing
 Other matching Venezia design accessories available

RRP (exc. GST)
 \$43.00

RRP (inc. GST)
 \$47.30

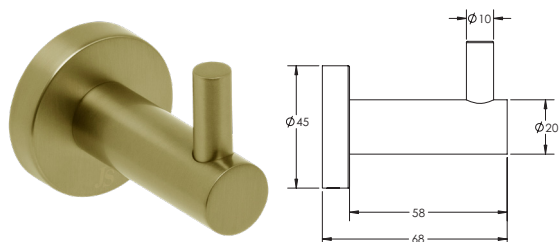

ACCESSORIES

VENEZIA SINGLE TOWEL RAIL 600MM CHROME

JACV600CH

600mm single bar towel rail
 Chrome finish
 Durable brass construction
 Simple, secure fixing
 Other Venezia design accessories available

RRP (exc. GST)
 \$64.00

RRP (inc. GST)
 \$70.40

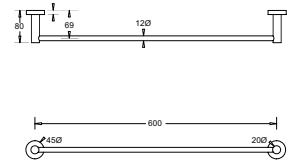

VENEZIA SINGLE TOWEL RAIL 600MM MATTE BLACK

JACV600EMB

600mm single bar towel rail
 Matte black finish
 Durable brass construction
 Simple, secure fixing
 Other Venezia design accessories available

RRP (exc. GST)
 \$98.00

RRP (inc. GST)
 \$107.80

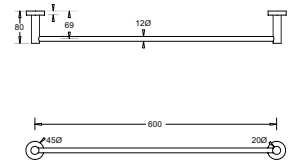

VENEZIA SINGLE TOWEL RAIL 600MM GUN METAL

JACV600EGM

600mm single bar towel rail
 Gun metal finish
 Durable brass construction
 Simple, secure fixing
 Other Venezia design accessories available

RRP (exc. GST)
 \$123.00

RRP (inc. GST)
 \$135.30

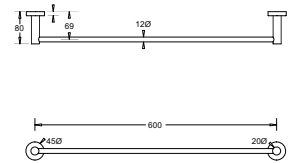

VENEZIA SINGLE TOWEL RAIL 600MM PVD BRUSHED NICKEL

JACV600PBN

600mm single bar towel rail
 Brushed nickel finish
 Durable brass construction
 Simple, secure fixing
 Other Venezia design accessories available

RRP (exc. GST)
 \$123.00

RRP (inc. GST)
 \$135.30

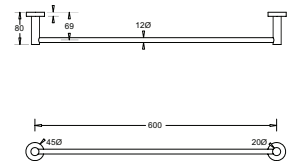

VENEZIA SINGLE TOWEL RAIL 600MM PVD BRUSHED BRASS

JACV600PBB

600mm single bar towel rail
 Brushed brass finish
 Durable brass construction
 Simple, secure fixing
 Other Venezia design accessories available

RRP (exc. GST)
 \$123.00

RRP (inc. GST)
 \$135.30

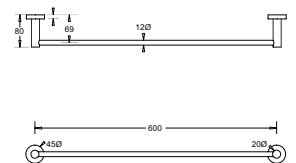

ACCESSORIES

VENEZIA DOUBLE TOWEL RAIL 600MM CHROME

JACV601CH

600mm double bar towel rail
 Chrome finish
 Durable brass construction
 Simple, secure fixing
 Other Venezia design accessories available

RRP (exc. GST)
 \$92.00

RRP (inc. GST)
 \$101.20

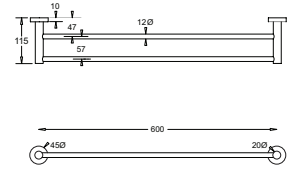

VENEZIA DOUBLE TOWEL RAIL 600MM MATTE BLACK

JACV601EMB

600mm double bar towel rail
 Matte black finish
 Durable brass construction
 Simple, secure fixing
 Other Venezia design accessories available

RRP (exc. GST)
 \$129.00

RRP (inc. GST)
 \$141.90

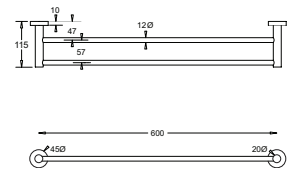

VENEZIA DOUBLE TOWEL RAIL 600MM GUN METAL

JACV601EGM

600mm double bar towel rail
 Gun metal finish
 Durable brass construction
 Simple, secure fixing
 Other Venezia design accessories available

RRP (exc. GST)
 \$151.00

RRP (inc. GST)
 \$166.10

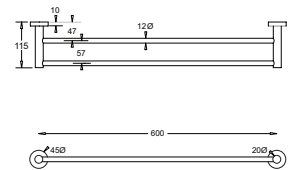

VENEZIA DOUBLE TOWEL RAIL 600MM PVD BRUSHED NICKEL

JACV601PBN

600mm double bar towel rail
 Brushed nickel finish
 Durable brass construction
 Simple, secure fixing
 Other Venezia design accessories available

RRP (exc. GST)
 \$151.00

RRP (inc. GST)
 \$166.10

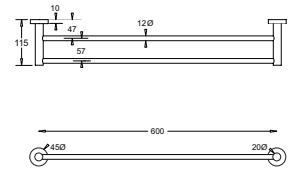

VENEZIA DOUBLE TOWEL RAIL 600MM PVD BRUSHED BRASS

JACV601PBB

600mm double bar towel rail
 Brushed brass finish
 Durable brass construction
 Simple, secure fixing
 Other Venezia design accessories available

RRP (exc. GST)
 \$151.00

RRP (inc. GST)
 \$166.10

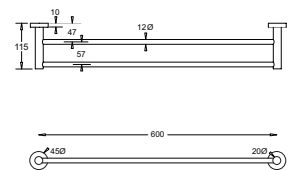

ACCESSORIES

VENEZIA SINGLE TOWEL RAIL 900MM CHROME

JACV900CH	RRP (exc. GST)	RRP (inc. GST)
	\$98.00	\$107.80
900mm single bar towel rail		
Chrome finish		
Durable brass construction		
Simple, secure fixing		
Other Venezia design accessories available		

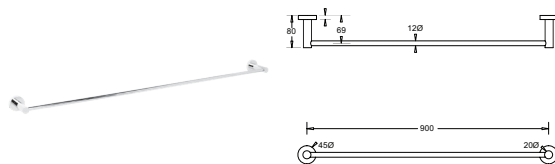

VENEZIA SINGLE TOWEL RAIL 900MM MATTE BLACK

JACV900EMB	RRP (exc. GST)	RRP (inc. GST)
	\$118.00	\$129.80
900mm single bar towel rail		
Matte black finish		
Durable brass construction		
Simple, secure fixing		
Other Venezia design accessories available		

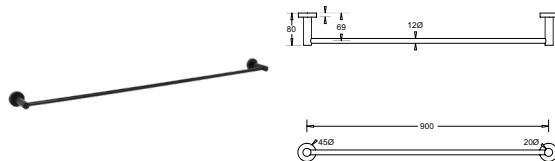

VENEZIA SINGLE TOWEL RAIL 900MM GUN METAL

JACV900EGM	RRP (exc. GST)	RRP (inc. GST)
	\$148.00	\$162.80
900mm single bar towel rail		
Gun metal finish		
Durable brass construction		
Simple, secure fixing		
Other Venezia design accessories available		

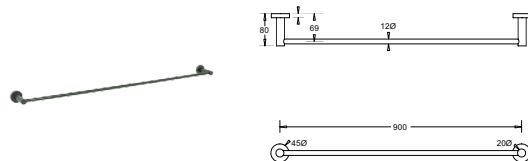

VENEZIA SINGLE TOWEL RAIL 900MM PVD BRUSHED NICKEL

JACV900PBN	RRP (exc. GST)	RRP (inc. GST)
	\$148.00	\$162.80
900mm single bar towel rail		
Brushed nickel finish		
Durable brass construction		
Simple, secure fixing		
Other Venezia design accessories available		

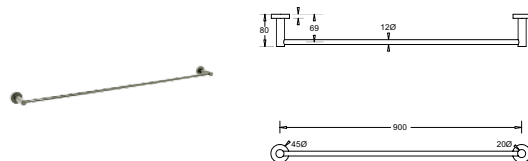

VENEZIA SINGLE TOWEL RAIL 900MM PVD BRUSHED BRASS

JACV900PBB	RRP (exc. GST)	RRP (inc. GST)
	\$148.00	\$162.80
900mm single bar towel rail		
Brushed brass finish		
Durable brass construction		
Simple, secure fixing		
Other Venezia design accessories available		

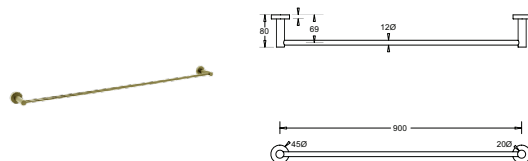

ACCESSORIES

VENEZIA DOUBLE TOWEL RAIL 900MM CHROME

JACV901CH	RRP (exc. GST)	RRP (inc. GST)
	\$123.00	\$135.30
900mm double bar towel rail		
Chrome finish		
Durable brass construction		
Simple, secure fixing		
Other Venezia design accessories available		

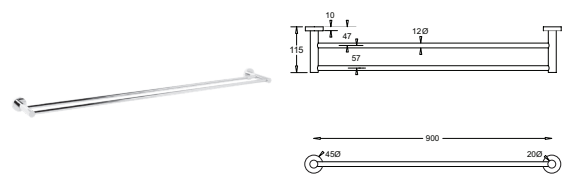

VENEZIA DOUBLE TOWEL RAIL 900MM MATTE BLACK

JACV901EMB	RRP (exc. GST)	RRP (inc. GST)
	\$154.00	\$169.40
900mm double bar towel rail		
Matte black finish		
Durable brass construction		
Simple, secure fixing		
Other Venezia design accessories available		

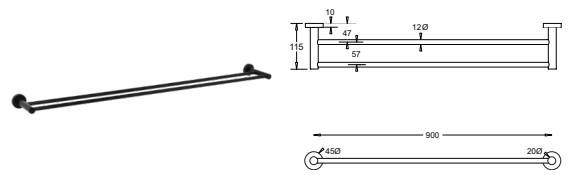

VENEZIA DOUBLE TOWEL RAIL 900MM GUN METAL

JACV901EGM	RRP (exc. GST)	RRP (inc. GST)
	\$174.00	\$191.40
900mm double bar towel rail		
Gun metal finish		
Durable brass construction		
Simple, secure fixing		
Other Venezia design accessories available		

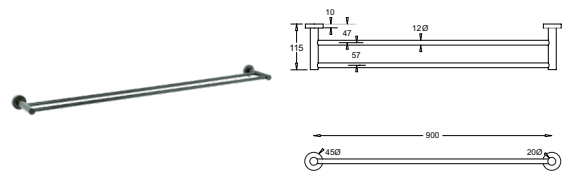

VENEZIA DOUBLE TOWEL RAIL 900MM PVD BRUSHED NICKEL

JACV901PBN	RRP (exc. GST)	RRP (inc. GST)
	\$174.00	\$191.40
900mm double bar towel rail		
Brushed nickel finish		
Durable brass construction		
Simple, secure fixing		
Other Venezia design accessories available		

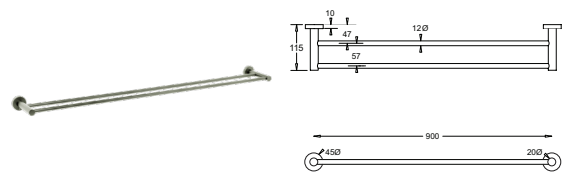

VENEZIA DOUBLE TOWEL RAIL 900MM PVD BRUSHED BRASS

JACV901PBB	RRP (exc. GST)	RRP (inc. GST)
	\$174.00	\$191.40
900mm double bar towel rail		
Brushed brass finish		
Durable brass construction		
Simple, secure fixing		
Other Venezia design accessories available		

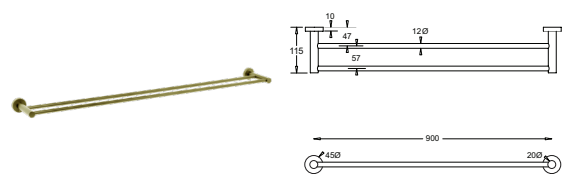

ACCESSORIES

VENEZIA POP-UP WASTE 32MM WITH OVERFLOW CHROME

PW5 **RRP (exc. GST)** \$34.00 **RRP (inc. GST)** \$37.40

32mm Pop-up basin waste with overflow
 Chrome finish
 Integrated Pop-Up plug with silicone sealing washer
 Designed for use with basin fitted with bowl overflows
 Durable brass construction

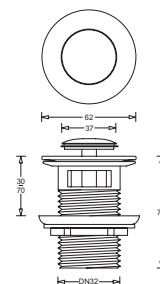

VENEZIA POP-UP WASTE 32MM WITH OVERFLOW MATTE BLACK

PW5EMB **RRP (exc. GST)** \$62.00 **RRP (inc. GST)** \$68.20

32mm Pop-up basin waste with overflow
 Matte black finish
 Integrated Pop-Up plug with silicone sealing washer
 Designed for use with basin fitted with bowl overflows
 Durable brass construction

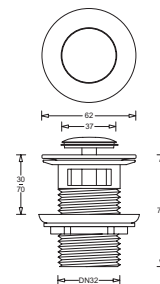

VENEZIA POP-UP WASTE 32MM WITH OVERFLOW GUN METAL

PW5EGM **RRP (exc. GST)** \$67.00 **RRP (inc. GST)** \$73.70

32mm Pop-up basin waste with overflow
 Gun metal finish
 Integrated Pop-Up plug with silicone sealing washer
 Designed for use with basin fitted with bowl overflows
 Durable brass construction

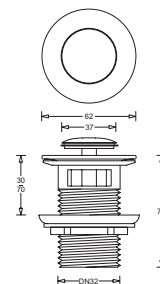

VENEZIA POP-UP WASTE 32MM WITH OVERFLOW PVD BRUSHED NICKEL

PW5PBN **RRP (exc. GST)** \$67.00 **RRP (inc. GST)** \$73.70

32mm Pop-up basin waste with overflow
 Brushed nickel finish
 Integrated Pop-Up plug with silicone sealing washer
 Designed for use with basin fitted with bowl overflows
 Durable brass construction

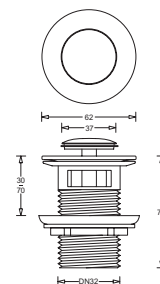

VENEZIA POP-UP WASTE 32MM WITH OVERFLOW PVD BRUSHED BRASS

PW5PBB **RRP (exc. GST)** \$67.00 **RRP (inc. GST)** \$73.70

32mm Pop-up basin waste with overflow
 Brushed brass finish
 Integrated Pop-Up plug with silicone sealing washer
 Designed for use with basin fitted with bowl overflows
 Durable brass construction

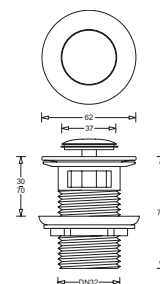

ACCESSORIES

VENEZIA POP-UP WASTE 32MM WITHOUT OVERFLOW CHROME

PW6 **RRP (exc. GST)** \$34.00 **RRP (inc. GST)** \$37.40

32mm Pop-up basin waste without overflow
 Chrome finish
 Integrated Pop-Up plug with silicone sealing washer
 Designed for use with basin with no bowl overflows
 Durable brass construction

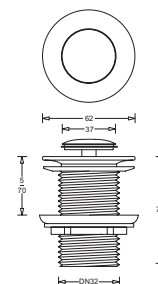

VENEZIA POP-UP WASTE 32MM WITHOUT OVERFLOW MATTE BLACK

PW6EMB **RRP (exc. GST)** \$62.00 **RRP (inc. GST)** \$68.20

32mm Pop-up basin waste without overflow
 Matte black finish
 Integrated Pop-Up plug with silicone sealing washer
 Designed for use with basin with no bowl overflows
 Durable brass construction

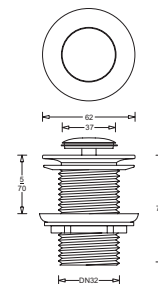

VENEZIA POP-UP WASTE 32MM WITHOUT OVERFLOW GUN METAL

PW6EGM **RRP (exc. GST)** \$67.00 **RRP (inc. GST)** \$73.70

32mm Pop-up basin waste without overflow
 Gun metal finish
 Integrated Pop-Up plug with silicone sealing washer
 Designed for use with basin with no bowl overflows
 Durable brass construction

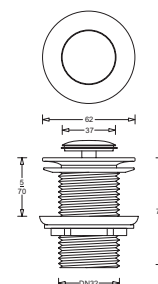
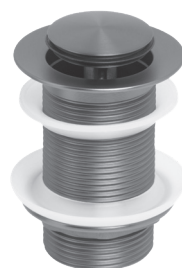

VENEZIA POP-UP WASTE 32MM WITHOUT OVERFLOW PVD BRUSHED NICKEL

PW6PBN **RRP (exc. GST)** \$67.00 **RRP (inc. GST)** \$73.70

32mm Pop-up basin waste without overflow
 Brushed nickel finish
 Integrated Pop-Up plug with silicone sealing washer
 Designed for use with basin with no bowl overflows
 Durable brass construction

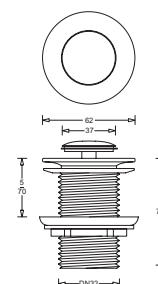

VENEZIA POP-UP WASTE 32MM WITHOUT OVERFLOW PVD BRUSHED BRASS

PW6PBB **RRP (exc. GST)** \$67.00 **RRP (inc. GST)** \$73.70

32mm Pop-up basin waste without overflow
 Brushed brass finish
 Integrated Pop-Up plug with silicone sealing washer
 Designed for use with basin with no bowl overflows
 Durable brass construction

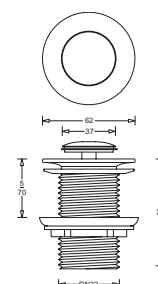

ACCESSORIES

VENEZIA BOTTLETRAP CHROME

BT2CH

32mm bottle trap
 Chrome finish
 Durable brass construction
 Fits 32mm waste outlets
 Vertically and horizontally adjustable

RRP (exc. GST)
 \$126.00

RRP (inc. GST)
 \$138.60

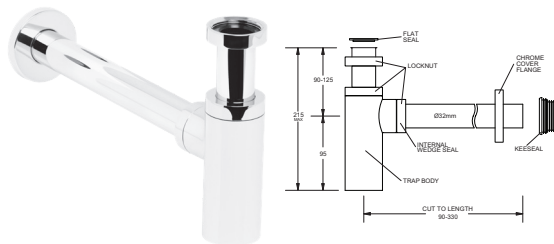

VENEZIA BOTTLETRAP MATTE BLACK

BT2EMB

32mm bottle trap
 Matte black finish
 Durable brass construction
 Durable brass construction
 Vertically and horizontally adjustable

RRP (exc. GST)
 \$188.00

RRP (inc. GST)
 \$206.80

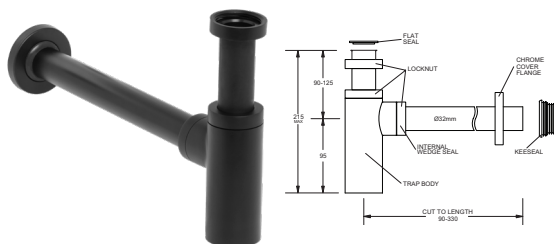

VENEZIA BOTTLETRAP GUN METAL

BT2EGM

32mm bottle trap
 Gun metal finish
 Durable brass construction
 Fits 32mm waste outlets
 Vertically and horizontally adjustable

RRP (exc. GST)
 \$219.00

RRP (inc. GST)
 \$240.90

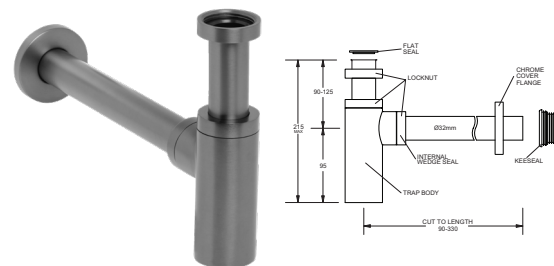

VENEZIA BOTTLETRAP PVD BRUSHED NICKEL

BT2PBN

32mm bottle trap
 Brushed nickel finish
 Durable brass construction
 Fits 32mm waste outlets
 Vertically and horizontally adjustable

RRP (exc. GST)
 \$219.00

RRP (inc. GST)
 \$240.90

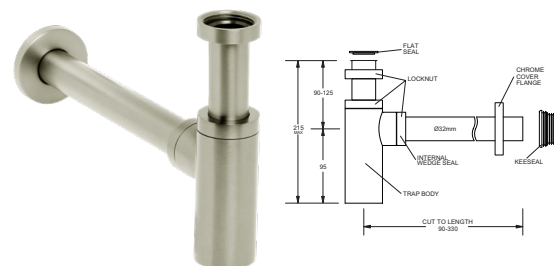

VENEZIA BOTTLETRAP PVD BRUSHED BRASS

BT2PBB

32mm bottle trap
 Brushed brass finish
 Durable brass construction
 Fits 32mm waste outlets
 Vertically and horizontally adjustable

RRP (exc. GST)
 \$219.00

RRP (inc. GST)
 \$240.90

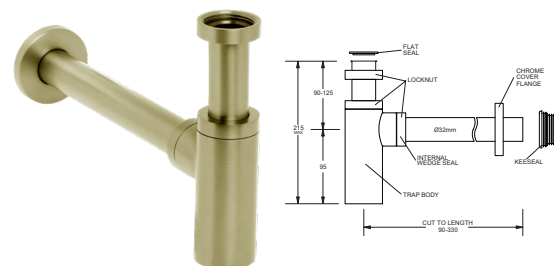

ACCESSORIES

FLINDERS SHOWER TIDY 2 TIER

TIMEDEAC

Vertical fixing rail with two glass shelves
 Corner mounted
 Chrome plated brass fittings
 Secure concealed DIY fixing system
 Tempered glass

RRP (exc. GST)
 \$136.00

RRP (inc. GST)
 \$149.60

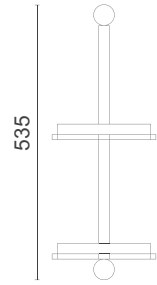

FLINDERS SHOWER TIDY 3 TIER

TIMEDEAC3

Vertical fixing rail with three glass shelves
 Corner mounted
 Chrome plated brass fittings
 Secure concealed DIY fixing system
 Tempered glass

RRP (exc. GST)
 \$157.00

RRP (inc. GST)
 \$172.70

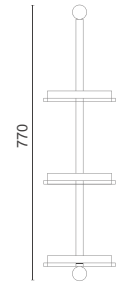

BATHS

Johnson Suisse Freestanding bathtubs embody luxury and indulgence. Made of durable sanitary grade acrylic, the Venezia freestanding baths are not only visually appealing but they also express elegance and everlasting style in your bathroom space. Johnson Suisse also offers attractive inset bathtub solutions available in different sizes and materials.



BATHS

BATH TYPES



Acrylic Freestanding

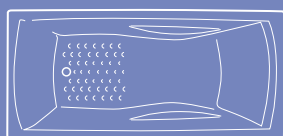

Acrylic Inset

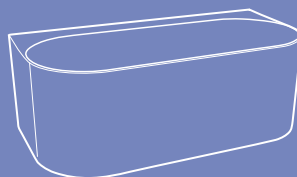

Acrylic Wall Faced

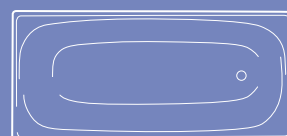

Vitreous Enamelled Steel



FREESTANDING BATHS



VENEZIA FREESTANDING ACRYLIC BATH 1580 / 1680

Code	RRP (exc. GST)	RRP (inc. GST)
JBFS158 - 1580 x 730 x 590	\$1,586.00	\$1,744.60
JBFS168 - 1680 x 750 x 590	\$1,632.00	\$1,795.20

- Fashionable European freestanding styling in durable gloss-white sanitary grade acrylic
- Generous depth and capacity
- Available in two sizes
- 40mm pop-up dome waste with overflow included (PW10)
- Optional 40mm pop-down waste available in 5 attractive finishes
- Easy installation with concealed adjustable legs
- Capacity 250L (JBFS158), 280L (JBFS168)

Optional Parts (not included)

40mm Pop-Down Waste With Overflow		
PW8 - Chrome	\$117.00	\$128.70
PW8B - Matte Black	\$192.00	\$211.20
PW8PGM - Gunmetal	\$192.00	\$211.20
PW8PBN - Brushed Nickel	\$192.00	\$211.20
PW8PBB - Brushed Brass	\$192.00	\$211.20
40mm Pop-Up Dome Waste With Overflow		
PW10 - Chrome	\$71.82	\$79.00



FREESTANDING BACK TO WALL

VENEZIA BACK TO WALL ACRYLIC BATH

Code	RRP (exc. GST)	RRP (inc. GST)
JBBTW150 - 1500 x 700 x 590	\$1,632.00	\$1,795.20
JBBTW170 - 1700 x 800 x 560	\$1,677.00	\$1,844.70

- Fashionable European styling in durable gloss-white sanitary grade acrylic
- One side fits flush to the wall
- Available in two sizes
- 40mm pop-up dome waste with overflow included (PW10)
- Optional 40mm pop-down waste available in 5 attractive finishes
- Easy installation with concealed adjustable legs
- Capacity 240L (JBBTW150), 270L (JBBTW170)

Optional Parts (not included)

40mm Pop-Down Waste With Overflow		
PW8 - Chrome	\$117.00	\$128.70
PW8B - Matte Black	\$192.00	\$211.20
PW8PGM - Gunmetal	\$192.00	\$211.20
PW8PBN - Brushed Nickel	\$192.00	\$211.20
PW8PBB - Brushed Brass	\$192.00	\$211.20
40mm Pop-Up Dome Waste With Overflow		
PW10 - Chrome	\$71.82	\$79.00



FREESTANDING CORNER

VENEZIA CORNER ACRYLIC BATH

Code	RRP (exc. GST)	RRP (inc. GST)
JBCL150 - 1500 x 700 x 590 (Left Hand)	\$1,614.00	\$1,775.40
JBCL170 - 1700 x 750 x 590 (Left Hand)	\$1,659.00	\$1,824.90
JBCR150 - 1500 x 700 x 590 (Right Hand)	\$1,614.00	\$1,775.40
JBCR170 - 1700 x 750 x 590 (Right Hand)	\$1,659.00	\$1,824.90

- Fashionable European styling in durable gloss-white sanitary grade acrylic
- Available in two sizes and Left and Right corner options
- 40mm pop-up dome waste with overflow included (PW10)
- Optional 40mm pop-down waste available in 5 attractive finishes
- Easy installation with concealed adjustable legs
- Capacity 270L (JBCL/R150), 330L (JBCL/R170)

Optional Parts (not included)

40mm Pop-Down Waste With Overflow		
PW8 - Chrome	\$117.00	\$128.70
PW8B - Matte Black	\$192.00	\$211.20
PW8PGM - Gunmetal	\$192.00	\$211.20
PW8PBN - Brushed Nickel	\$192.00	\$211.20
PW8PBB - Brushed Brass	\$192.00	\$211.20
40mm Pop-Up Dome Waste With Overflow		
PW10 - Chrome	\$71.82	\$79.00



INSET BATHS

PROJECT PREMIUM INSET

Code	RRP (exc. GST)	RRP (inc. GST)
J5115A 1500mm (L) x 723mm (W) x 415mm (H)	\$380.00	\$418.00
J5116A 1675mm (L) x 738mm (W) x 415mm (H)	\$424.00	\$466.40

- Contemporary bath design
- Sanitary grade acrylic, fibreglass reinforced with polyester resin
- Integrated tiling lip on all edges
- Slip resistant surface on base
- Integrated self-supporting base board for easy installation
- Capacity 230L (J5116)
- Extra thick resin backing that increases strength and durability

Optional Parts (not included)

40mm Plug & Waste PW3	\$66.00	\$72.60
-----------------------	---------	---------



SELECT MKII

Code	RRP (exc. GST)	RRP (inc. GST)
J5152 1520mm (L) x 750mm (W) x 420mm (H)	\$547.00	\$601.70
J5166 1660mm (L) x 750mm (W) x 420mm (H)	\$598.00	\$657.80

- Rectangular form bath design
- Sanitary grade acrylic, fibreglass reinforced with polyester resin
- Integrated tiling lip on all edges
- Slip resistant surface on base
- Integrated self-supporting base board for easy installation
- Made of 3.2mm thick PMMA acrylic with 3.5mm of resin/ fibreglass reinforcement
- Capacity 175L (J5152), 210L (J5166)

Optional Parts (not included)

40mm Plug & Waste PW3	\$66.00	\$72.60
-----------------------	---------	---------



SELECT MKII 1800

Code	RRP (exc. GST)	RRP (inc. GST)
J5180 1800mm (L) x 800mm (W) x 480mm (H)	\$780.00	\$858.00

- Rectangular form twin bath design
- Sanitary grade acrylic, fibreglass reinforced with polyester resin
- Integrated tiling lip on all edges
- Integrated self-supporting base board for easy installation
- Centre outlet
- Capacity 280L

Optional Parts (not included)

40mm Plug & Waste PW3	\$66.00	\$72.60
-----------------------	---------	---------



VITREOUS ENAMELLED STEEL

ULTRA COMPACT BATH

Code	RRP (exc. GST) RRP (inc. GST)	
J5060 1200mm (L) x 700mm (W) x 370mm (H)	\$486.00	\$534.60

- Quality European manufactured pressed steel bath
- Durable scratch resistant vitreous enamelled finish
- Modern styling with simple easy-clean lines
- Suitable for commercial or domestic installation
- Comfortable shape with generous depth
- Optional screw-adjustable legs available
- Perfect for smaller spaces
- Built-in seat for added comfort and safe seating for children



Optional Parts *(not included)*

Ultra Compact 1050 Bath Leg Set J5051	\$72.00	\$79.20
--	---------	---------

ESTI

Code	RRP (exc. GST) RRP (inc. GST)	
Bath without anti slip surface		
J5010 1500mm (L) x 700mm (W) x 385mm (H)	\$545.00	\$599.50
J5000 1700mm (L) x 700mm (W) x 385mm (H)	\$632.00	\$695.20

- Modern, comfortable bath design
- European quality pressed steel bath
- Durable scratch-resistant enamel
- Capacity 170L (J5010), 190L (J5000)



Optional Parts *(not included)*

Plug & Waste PW3	\$66.00	\$72.60
------------------	---------	---------

SHOWER SYSTEMS

A beautiful, modern shower doesn't have to be expensive. With clean lines and smooth finishes, your Marbletrend shower system is an investment in luxury.

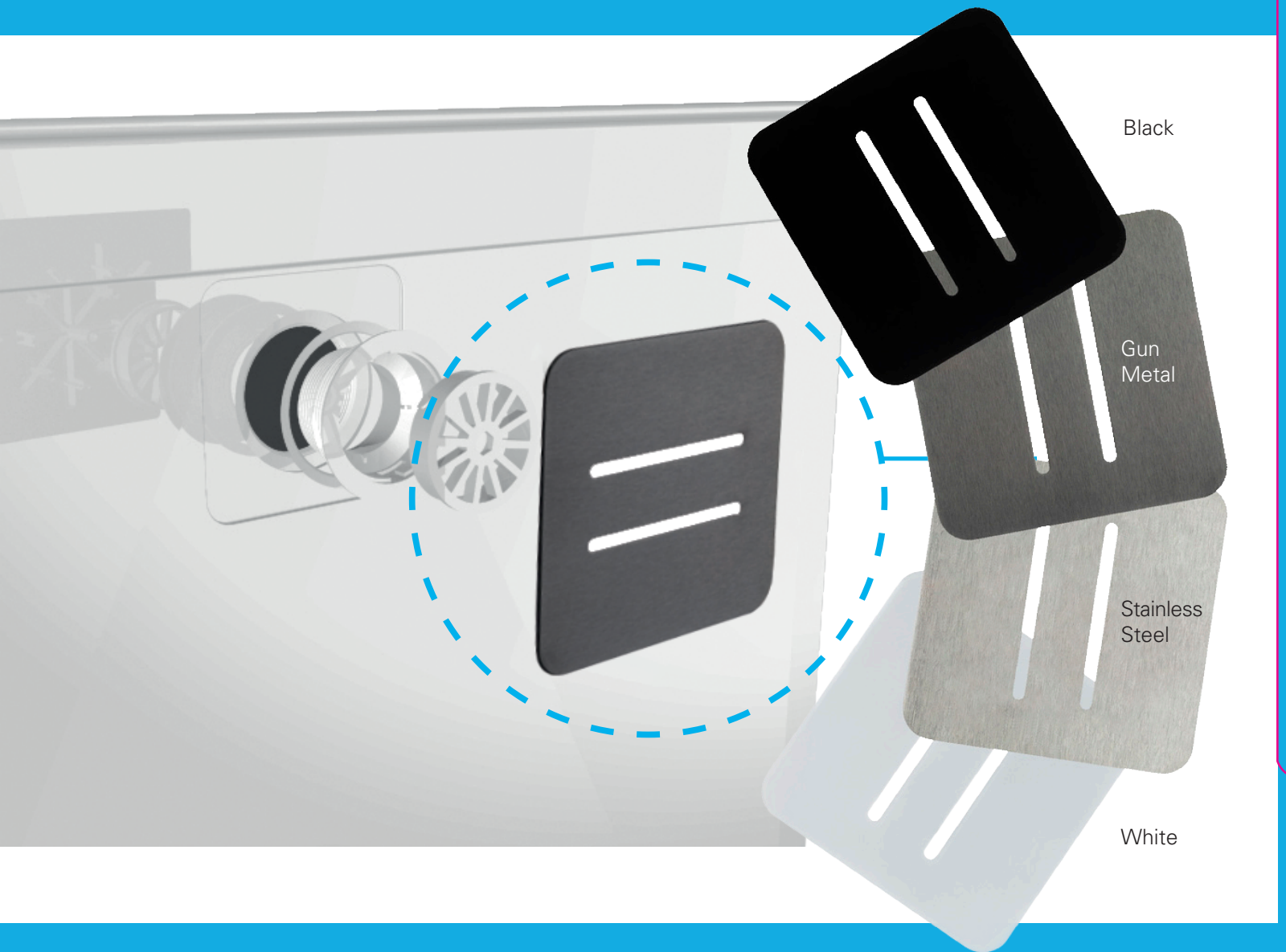

SHOWER BASE TYPES

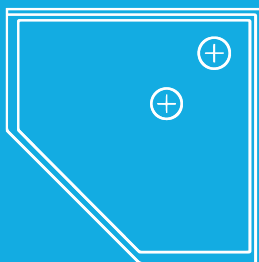

Corner Base

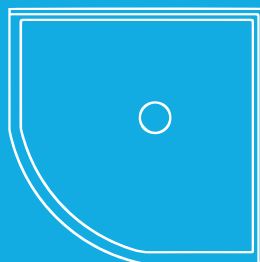

Curved Corner Base

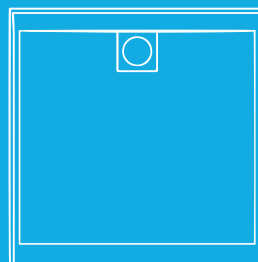

Rectangular Base

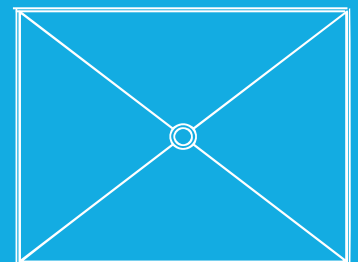

Tile Tray



JohnsonSuisse

Water has the ability to transform our mood and alter our state of mind. At Marbletrend, we're committed to bring you the ultimate transformative innovations throughout the shower system category. From Australian made shower bases, shower screens and panels, inviting baths, showers and tapware, Marbletrend draws on cutting-edge technologies in product development to meet the 'Aussie' way of life.

Focusing on the human connection to water we deliver on refreshingly simple and eye-catching designs for the entire family. What sets Marbletrend apart is its approach to sustainable, authentic shower system solutions.



SHOWER SYSTEMS – SHOWER BASES RETURNS EXPLAINED

Left hand and right hand return refers to the orientation of the tile flange (lip), in relation to the rear waste and front entry.

3 SIDED BASE

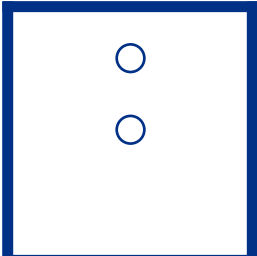

ALCOVE

A base that has 3 tile lips

4 SIDED BASE

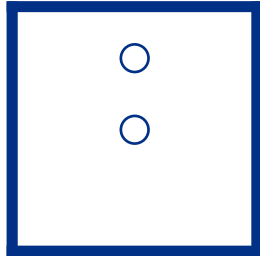

4 TILE LIPS

A base that has 4 tile lips

LH RETURN BASE (LH. Ret.)

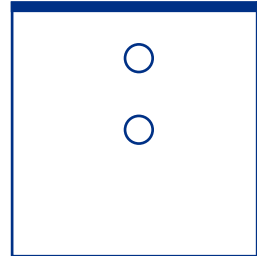

2 TILE LIPS

Left hand return or right hand Return - Rear Outlet Waste

DOUBLE ENTRY (Dbl. E.)

A base with a centre outlet waste with 2 tile lips, meaning it can be either a LH or RH return

RH RETURN BASE (RH. Ret.)

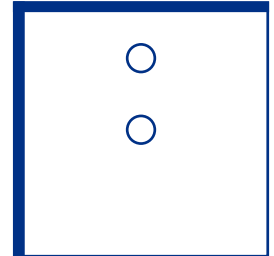

MARBLETREND SHOWER EXPLAINED

A beautiful, modern shower doesn't have to be expensive. With clean lines and smooth finishes, your Marbletrend shower is an investment in luxury. Marbletrend makes it easy to combine individual elements together to create the perfect shower system

3 STEPS PROCESS



STEP 1 CHOOSE A SHOWER SCREEN

SHOWER SCREEN

All of Marbletrend Shower screens are frameless, semi-frameless or fully framed and pre-treated with Enduro-Shield®, reducing glass cleaning by up to 90%.



STEP 2 CHOOSE A SHOWER BASE

SHOWER BASE

- Available in different sizes and shapes to suit any bathroom
 - Easy installation for DIY installers
 - Patented "Top Fix" Self supporting waste
- *not all bases



STEP 3 CHOOSE A SHOWER WALL

SHOWER WALL

Marbletrend's acrylic shower walls feature Antibac® antimicrobial protection to minimise the growth of bacteria in the shower, ensuring they are effortless to keep clean.

CREATE YOUR PERFECT SHOWER SYSTEM

1. CHOOSE A SHOWER SCREEN | 2. CHOOSE A SHOWER BASE | 3. CHOOSE A SHOWER WALL



FLINDERS

- NEW FLINDERS SHOWER BASE
- FLINDERS SMC BASE
- FLINDERS POLYMARBLE BASE
- SHOWER WALL



FLINDERS NEO

- FLINDERS SMC BASE
- FLINDERS POLYMARBLE CORNER BASE
- SHOWER WALL



FLINDERS SHOWER PANEL

- NEW FLINDERS SHOWER BASE
- FLINDERS SMC BASE
- FLINDERS POLYMARBLE BASE
- SHOWER WALL



DAINTREE

- DAINTREE POLYMARBLE BASE
- SHOWER WALL



DAINTREE CURVED

- EVO POLYMARBLE CURVED BASE
- SHOWER WALL



BAROSSA SLIDER

- BAROSSA POLYMARBLE BASE
- TILE TRAY
- SHOWER WALL



BAROSSA PIVOT

- BAROSSA POLYMARBLE BASE
- TILE TRAY
- SHOWER WALL



BAROSSA PIVOT FRAMELESS

- BAROSSA POLYMARBLE BASE
- TILE TRAY
- SHOWER WALL



CORSICA SLIDER

- BAROSSA POLYMARBLE BASE
- SHOWER WALL



CORSICA BI-FOLD

- BAROSSA POLYMARBLE BASE
- SHOWER WALL



STANDARD SHOWER WALL

- ALL BASES
- ALL SCREENS
- 3 SIDED WALLS SUIT SMC BASE ONLY



KIMBERLEY SHOWER WALL

- DESIGNED FOR SHORTER
- SCREENS 1830MM HEIGHT

NEW FLINDERS SHOWER BASE

The most exciting innovation to shower base technology in more than 20 years.

Eliminating the need for a mortar bed, the New Flinders shower base made from Marblelite, a long-lasting solid cast formula, is self-supporting and comes with a three tile flange and square waste cover as standard.



FEATURES & BENEFITS

- Slimline profile crafted with in-built E-sphere network
- Available in two sizes:
900mm x 900mm / 1220mm x 900mm
- Patented "Top Fix" innovation for fast, simple and affordable installation
- Square waste cover (easily removed for cleaning)
- Alternative finished metallic waste covers available
- Two, three and four sided tile flange offers flexibility of installation
- Durable gel coating chemically resistant
- 20 year manufacturer warranty

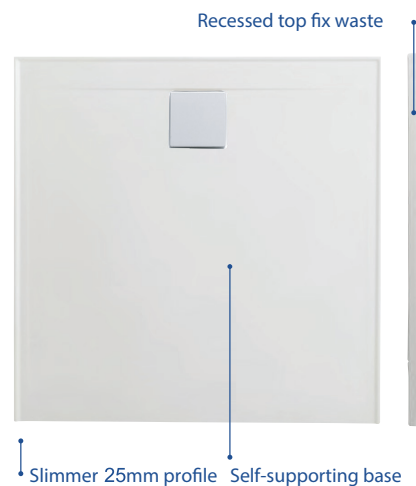

SPECIFICATIONS

Sizes (mm)	900W x 900D x 35H 1220W x 900D x 35H
Material	MarbleLite™
Color	White

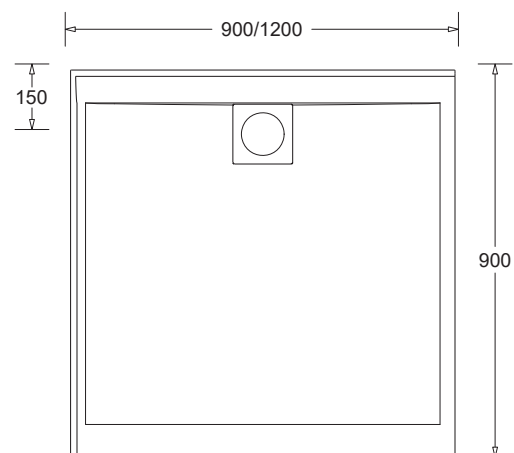

SHOWER BASES



NEW FLINDERS

First dimension refers to the entrance size. All measurements given in mm

SQUARE Rear Outlet

Code	Size	RRP exc.GST	RRP inc. GST
MSBF26CW.KW	900x900 (3 sided)	\$396.00	\$435.60
MSBF26LCW.KW	900x900 (L/H return)	\$396.00	\$435.60
MSBF26RCW.KW	900x900 (R/H return)	\$396.00	\$435.60
MSBF26CW4	900x900 (4 sided)	\$396.00	\$435.60

RECTANGULAR Rear Outlet

Code	Size	RRP exc.GST	RRP inc. GST
MSBF34CW.KW	1220x900 (3 sided)	\$574.00	\$631.40
MSBF34LCW.KW	1220x900 (L/H return)	\$574.00	\$631.40
MSBF34RCW.KW	1220x900 (R/H return)	\$574.00	\$631.40
MSBF34CW4	1220x900 (4 sided)	\$574.00	\$631.40

Optional finished metallic waste cover (not included):

Code	Colour	RRP exc.GST	RRP inc.GST
FGST	Stainless Steel	\$52.00	\$57.20
FGW	White	\$60.00	\$66.00
FGG	Gun Metal	\$69.00	\$75.90
FGMB	Matte Black	\$69.00	\$75.90

Optional Spare Parts

OUCWTF - 108mm Top Fix Waste Kit White	\$30.00	\$33.00
OUSQCW - Marbletrend Square Dome White	\$21.00	\$23.10

The New Flinders shower base is manufactured in Australia and it is made of Marblelite, a lightweight, self supporting, long-lasting solid cast formula that allows a reliably straight, modern and slimline shower base. The patented "Top Fix" waste system allows for fast, simple, and affordable installation on all floor surfaces including Smart Pans giving a convenient, seamless and beautiful finish to suit any bathroom space and design.

- Slimline profile crafted with inbuilt E-sphere network
- Patented "Top Fix" waste system for easy install on all floor surfaces including Smart Pans
- Square waste cover (easily removed for cleaning)
- Two or three-sided tile flange, left hand and right hand return
- Durable gel coat surface, sanitary grade, stain and chemical resistant

Shower Screen Compatibility:

Flinders p10



Note: For all dimensions and technical information please visit www.marbletrend.com.au

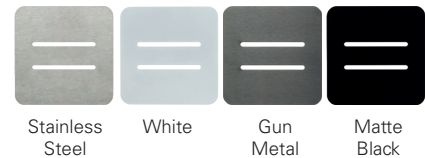

DAINTREE POLYMARBLE

First dimension refers to the entrance size. All measurements given in mm

SQUARE Rear Outlet

Code	Size	RRP exc.GST	RRP inc. GST
SBD16CW	820x820 White	\$473.00	\$520.30
SBD26CW	900x900 White	\$473.00	\$520.30
SBD40CW	1000x1000 White	\$658.00	\$723.80

RECTANGULAR Rear Outlet

Code	Size	RRP exc.GST	RRP inc. GST
SBD34CW	1220x900 White	\$756.00	\$831.60

Optional Spare Parts

OUSQCW - Marbletrend Square Dome White	\$21.00	\$23.10
OUCW - Waste Outlet White Grate Only	\$14.00	\$15.40

The Daintree Polymarble shower base is self-supporting for easy installation and features extra protection against leaks with built-in lips on all four sides.

- No grout and no joins, making it easy to clean
- Self-supporting for easy installation
- Solid, hard wearing material

Shower Screen Compatibility

Flinders	p10
Daintree Square	p11
Barossa Slider	p12
Barossa Semi-Frameless	p13
Barossa Frameless	p13
Corsica Slider	p14
Corsica Bi - Fold	p15



Note: For all dimensions and technical information please visit www.johnsonsuiss.com.au

SHOWER BASES



FLINDERS POLYMARBLE

First dimension refers to the entrance size. All measurements given in mm

SQUARE Centre Outlet

Code	Size	RRP exc.GST	RRP inc. GST
SB17CW	820x820 White	\$422.00	\$464.20
SB15CW	820x820 White Dbl. E.	\$422.00	\$464.20
SB28CW	900x900 White	\$422.00	\$464.20
SB19CW	900x900 White Dbl. E.	\$422.00	\$464.20
SB48CW	1000x1000 White Dbl. E.	\$617.00	\$678.70

SQUARE Rear Outlet

Code	Size	RRP exc.GST	RRP inc. GST
SB16CW	820x820 White	\$422.00	\$464.20
SB1LCW	820x820 White LH Ret.	\$422.00	\$464.20
SB1RCW	820x820 White RH Ret.	\$422.00	\$464.20
SB26CW	900x900 White	\$449.00	\$493.90
SB2LCW	900x900 White LH Ret.	\$444.00	\$488.40
SB2RCW	900x900 White RH Ret.	\$444.00	\$488.40
SB40CW	1000x1000 White	\$617.00	\$678.70
SB4LCW	1000x1000 White LH Ret.	\$617.00	\$678.70
SB4RCW	1000x1000 White RH Ret.	\$617.00	\$678.70
SB10CW - MTO*	760x760 White	\$630.00	\$693.00

SQUARE Front Outlet

Code	Size	RRP exc.GST	RRP inc. GST
SB25CW - MTO*	900x900 White	\$604.00	\$664.40

RECTANGULAR Centre Outlet

Code	Size	RRP exc.GST	RRP inc. GST
SB41CW	1220x900 White	\$617.00	\$678.70
SB6LCW	1220x900 White LH Ret.	\$617.00	\$678.70
SB6RCW	1220x900 White RH Ret.	\$617.00	\$678.70
SB43CW - MTO*	900 x 1060 White	\$749.00	\$823.90
SB44CW - MTO*	900 x 820 White	\$749.00	\$823.90
SB46CW - MTO*	820 x 1060 White	\$749.00	\$823.90
SB47CW - MTO*	1220 x 780 White	\$749.00	\$823.90
SB50CW - MTO*	1500 x 820 White	\$1,366.00	\$1,502.60
SB51CW - MTO*	820 x 900 White	\$749.00	\$823.90
SB52CW - MTO*	1220 x 820 White	\$749.00	\$823.90
SB53CW - MTO*	1060 x 900 White	\$749.00	\$823.90

RECTANGULAR Rear Outlet

Code	Size	RRP exc.GST	RRP inc. GST
SB32CW	1220x820 White	\$617.00	\$678.70
SB3LCW	1220x900 White LH Ret.	\$648.00	\$712.80
SB3RCW	1220x900 White RH Ret.	\$648.00	\$712.80
SB33CW	900x1220 White	\$617.00	\$678.70
SB5LCW	900x1220 White LH Ret.	\$617.00	\$678.70
SB5RCW	900x1220 White RH Ret.	\$617.00	\$678.70
SB37CW	1500x900 White	\$1,103.00	\$1,213.30
SB12CW - MTO*	760x820 White	\$630.00	\$693.00
SB14CW - MTO*	820x760 White	\$630.00	\$693.00
SB18CW - MTO*	760x900 White	\$630.00	\$693.00
SB20CW - MTO*	900x760 White	\$630.00	\$693.00
SB22CW - MTO*	900x820 White	\$630.00	\$693.00
SB24CW - MTO*	820x900 White	\$630.00	\$693.00
SB27CW - MTO*	990x760 White	\$630.00	\$693.00
SB30CW - MTO*	1060x820 White	\$726.00	\$798.60
SB31CW - MTO*	1060x900 White	\$726.00	\$798.60
SB42CW - MTO*	1220x1000 White	\$749.00	\$823.90
SB36CW - MTO*	1370x900 White	\$1,366.00	\$1,502.60
SB80CW - MTO*	1800x900 White	\$1,898.00	\$2,087.80



Note: For all dimensions and technical information please visit www.marbletrend.com.au

The Flinders Square Shower base is made from Polymerable – a hard-wearing, solid, fully-moulded material ideal for bathroom surfaces.

- No grout and no joins, easy to clean
- Fully integrated waste

Shower Screen Compatibility

Flinders p15

MTO* Made to Order

SHOWER BASES



EVO POLYMARBLE

First dimension refers to the entrance size. All measurements given in mm

SQUARE Rear Outlet

Code	Size	RRP exc.GST	RRP inc. GST
EV26CW	900x900 White	\$619.00	\$680.90
EV2LCW	900x900 White LH Ret.	\$619.00	\$680.90
EV2RCW	900x900 White RH Ret.	\$619.00	\$680.90
EV40CW	1000x1000 White	\$786.00	\$864.60
EV4LCW	1000x1000 White LH Ret.	\$786.00	\$864.60
EV4RCW	1000x1000 White RH Ret.	\$786.00	\$864.60
EV16CW - MTO*	820x820 White	\$747.00	\$821.70

RECTANGULAR Rear Outlet

Code	Size	RRP exc.GST	RRP inc. GST
EV33CW	900 x 1220 White	\$819.00	\$900.90
EV34CW	1220x900 White	\$819.00	\$900.90
EV3LCW	1220x900 White LH Ret.	\$819.00	\$900.90
EV3RCW	1220x900 White RH Ret.	\$819.00	\$900.90
EV37CW	1500x900 White	\$1,374.00	\$1,511.40
EV36CW - MTO*	1370 x 900 White	\$1,445.00	\$1,589.50
EV38CW - MTO*	1660 x 900 White	\$1,672.00	\$1,839.20

Optional Spare Parts

OUCW - Waste Outlet White Grate Only	\$14.00	\$15.40
OUDOCW - Round Dome Cover White For Evo	\$42.00	\$46.20

Eliminating the need for a mortar bed, the Evo Polymarble shower base is self supporting for easy installation, and comes with an anti-skid surface and built-in lips.

- No grout, no joins, easy to clean
- Self-supporting for easy installation
- Solid, hard wearing material
- Perimeter draining
- Water return wells stops external leaking

Shower Screen Compatibility

Flinders p10

MTO* Made to Order



Note: For all dimensions and technical information please visit www.johnsonsisuisse.com.au

BAROSSA POLYMARBLE

First dimension refers to the entrance size. All measurements given in mm

SQUARE Rear Outlet

Code	Size	RRP exc.GST	RRP inc. GST
KSBB26CW	900x900 White	\$666.00	\$732.60
KSBB40CW	1000x1000 White	\$861.00	\$947.10

RECTANGULAR Rear Outlet

Code	Size	RRP exc.GST	RRP inc. GST
KSBB34CW	1220x900 White	\$897.00	\$986.70
KSBB37CW	1500x900 White	\$1,353.00	\$1,488.30

The Barossa Polymarble shower base is a modern, low-profile, self-supporting shower base featuring a stylish stainless steel channel grate and extra protection against leaks, with built-in lips on all four sides.

- No grout and no joins, making it easy to clean
- Self-supporting for easy installation
- Solid, hard wearing material

Shower Screen Compatibility

Flinders	p10
Daintree Square	p11
Barossa Slider	p12
Barossa Semi-Frameless	p13
Barossa Frameless	p13
Corsica Slider	p14
Corsica Bi - Fold	p15



Note: For all dimensions and technical information please visit www.johnsonsisuisse.com.au

SHOWER BASES

FLINDERS SMC

First dimension refers to the entrance size. All measurements given in mm

SQUARE Centre Outlet

Code	Size	RRP exc.GST	RRP inc. GST
MSBU928	900x900 White 4 Tile Lips	\$297.00	\$326.70

SQUARE Rear Outlet

Code	Size	RRP exc.GST	RRP inc. GST
MSBU926	900x900 White 3 Tile Lips	\$297.00	\$326.70

RECTANGULAR Rear Outlet

Code	Size	RRP exc.GST	RRP inc. GST
MSBU934	1200x900 White 3 Tile Lips	\$400.00	\$440.00

Optional Spare Parts

OUUBWH.AP - Flinders SMC Ultralite Waste	\$30.00	\$33.00
--	---------	---------

The Flinders SMC shower base is the lightest supporting shower base in the Marbletrend range.

- No grout and no joins, making it easy to clean
- Lightest shower base in the range, for easy installation

Shower Screen Compatibility

Flinders	p10	Barossa Frameless	p13
Daintree Square	p11	Corsica Slider	p14
Barossa Slider	p12	Corsica Bi - Fold	p15
Barossa Semi-Frameless	p13		



Note: For all dimensions and technical information please visit www.marbletrend.com.au

FLINDERS POLYMARBLE NEO

CORNER Centre Outlet

Code	Size	RRP exc.GST	RRP inc. GST
SB69CW	914x914 White	\$473.00	\$520.30
SB79CW	1000x1000 White	\$580.00	\$638.00

CORNER Rear Outlet

Code	Size	RRP exc.GST	RRP inc. GST
SB39CW	914x914 White	\$473.00	\$520.30
SB29CW	1000x1000 White	\$580.00	\$638.00
SB59CW - MTO*	1200x1200 White	\$1,026.00	\$1,128.60

The Flinders Polymerble shower base is made from Marblelite™ – a hard wearing, solid, fully moulded material ideal for bathroom surfaces.

- No grout and no joins, easy to clean
- Available only in 2 lip models
- Fully integrated waste
- Non self-supporting

Shower Screen Compatibility

Flinders Neo	p11
--------------	-----

MTO* Made to Order



Note: For all dimensions and technical information please visit www.marbletrend.com.au

EVO POLYMARBLE NEO

CORNER Rear Outlet

Code	Size	RRP exc.GST	RRP inc. GST
EV39CW	914x914 White	\$569.00	\$625.90
EV29CW	1000x1000 White	\$749.00	\$823.90
EV59CW - MTO*	1200x1200 White	\$1,173.00	\$1,290.30

Eliminating the need for a mortar bed, the Evo Polymerble shower base is self supporting for easy installation, and comes with an anti-skid surface and built-in lips.

- No grout, no joins, easy to clean
- Self-supporting for easy installation
- Solid, hard wearing material

Shower Screen Compatibility

Flinders Neo	p11
--------------	-----

MTO* Made to Order



Note: For all dimensions and technical information please visit www.johnsonssuisse.com.au

SHOWER BASES

FLINDERS SMC NEO

CORNER Centre Outlet

Code	Size	RRP exc.GST	RRP inc. GST
MSBU969	900x900 White 2 Tile Lips	\$304.00	\$334.40

The Flinders SMC shower base is an innovative product, and the lightest and most durable self supporting shower base in the Marbletrend range.

- No grout and no joins, making it easy to clean
- Lightest shower base in the range, for easy installation

Shower Screen Compatibility

Flinders Neo p11



Note: For all dimensions and technical information please visit www.johnsonsuisse.com.au

FLINDERS POLYMARBLE CURVED

CURVED Centre Outlet

Code	Size	RRP exc.GST	RRP inc. GST
SB88CW	914x914 White	\$493.00	\$542.30
SB98CW	1000x1000 White	\$580.00	\$638.60

CURVED Rear Outlet

Code	Size	RRP exc.GST	RRP inc. GST
SB89CW	914x914 White	\$493.00	\$542.30
SB99CW	1000x1000 White	\$580.00	\$638.60

The Flinders Polymarble shower base is made from Marblelite™ – a hard wearing, solid, fully moulded material ideal for bathroom surfaces.

- No grout and no joins, easy to clean
- 2 sided 17mm built-in lips
- Fully integrated waste
- Non self-supporting

Shower Screen Compatibility

Daintree Curved p12

MTO* Made to Order



Note: For all dimensions and technical information please visit www.johnsonsuisse.com.au

EVO POLYMARBLE CURVED

CURVED Rear Outlet

Code	Size	RRP exc.GST	RRP inc. GST
EV89CW	914x914 White	\$569.00	\$625.90
EV99CW	1000x1000 White	\$749.00	\$823.90

Eliminating the need for a mortar bed, the Evo Polymarble shower base is self supporting for easy installation, and comes with an anti-skid surface and built-in lips.

- No grout, no joins, easy to clean
- Self-supporting for easy installation
- Solid, hard wearing material

Shower Screen Compatibility

Daintree Curved p12

MTO* Made to Order



Note: For all dimensions and technical information please visit www.johnsonsuisse.com.au

SHOWER TILES TRAY

TILE TRAY

First dimension refers to the entrance size. All measurements given in mm

SQUARE

Code	Size	RRP exc.GST	RRP inc. GST
MSB728PF	895W x 895D x 60H	\$341.00	\$375.10
MSB748PF	995W x 995D x 60H	\$477.00	\$524.70

RECTANGULAR

Code	Size	RRP exc.GST	RRP inc. GST
MSB741PF	1200W x 895D x 60H	\$529.00	\$581.90

Marbletrent's Tile Tray provides the look of a tiled floor, with the waterproofing of a base. The Tile Tray is structurally sound, self-draining and can be installed directly onto floor joist.

- Self-supporting and easy to trim for easy installation
- No joins – 1 piece with moulded lip
- Made from Bulk Moulding Compound (high compression moulded material)



Note: For all dimensions and technical information please visit www.marbletrent.com.au

SHOWER SCREENS



Enduroshield

Enduroshield hydrophobic coating creates a non-stick barrier resistant to corrosion, etching, and staining.

FLINDERS SHOWER SCREEN

All measurements given in mm

DOOR PANEL SET

Code GST	Size	RRP exc.GST	RRP inc.
SSFL16CHCLP	820 - Chrome (actual size 750 - 810)	\$504.00	\$554.40
SSFL26CHCLP	900 - Chrome (actual size 830 - 890)	\$562.00	\$618.20
SSFL26MBCLP	900 - Black (actual size 830 - 890)	\$573.00	\$630.30
SSFL40CHCLP	1000 - Chrome (actual size 930-990)	\$574.00	\$631.40
SSFL34CHCLP	1220 - Chrome (actual size 1140-1200)	\$629.00	\$691.90
SSFL34MBCLP	1220 - Black (actual size 1140-1200)	\$641.00	\$705.10
SSFL37CHCLP	1500 - Chrome (actual size 1430-1490)	\$687.00	\$755.70

RETURN PANEL SET

Code GST	Size	RRP exc.GST	RRP inc.
SSFL16CHCLR	820 - Chrome (actual size 770 - 800)	\$285.00	\$313.50
SSFL26CHCLR	900 - Chrome (actual size 835 - 870)	\$306.00	\$336.60
SSFL26MBCLR	900 - Black (actual size 835 - 870)	\$312.50	\$343.20
SSFL40CHCLR	1000 - Chrome (actual size 935 - 970)	\$300.00	\$330.00
SSFL34CHCLR	1200 - Chrome (actual size 1155-1190)	\$363.00	\$399.30

Available in 27 configurations, the Flinders shower screen is the most versatile screen in the Marbletrent range. The design of the semi-frameless door and return panel is modern, elegant and easy to clean.

- Most versatile screen
- Large adjustment range for the perfect fit
- Safety Glass
- Fully reversible

Height	2000 mm
Glass Thickness	6 mm
Colours	Chrome
Material	Toughened safety glass to AU Standards AS/NZS 2208:1996
Tiled Floor Suitable	Yes
Alcoves Suitable	Yes
Base Compatibility	
New Flinders	p5
Flinders Polymarble	p6
Evo	p7
All Bases	

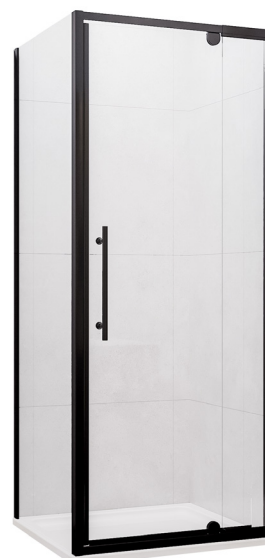

SHOWER SCREENS



FLINDERS NEO SHOWER SCREEN

All measurements given in mm

FRONT & RETURN PANEL SET

Code	Size	RRP exc.GST	RRP inc. GST
KSSFL69CHCLP	900x900 - Chrome (Actual size 835 - 895 each side)	\$899.00	\$988.90

The Flinders Neo shower screen has a large adjustment range for easy DIY installations. The design of the semi-frameless door and return panel is modern, elegant and easy to clean.

- Large adjustment range for the perfect fit
- Safety Glass

Height	2000 mm
Glass Thickness	6 mm
Colours	Chrome

Material Toughened safety glass to AU Standards AS/NZS 2208:1996

Tiled Floor Suitable Yes

Base Compatibility

Flinders Polymarble	p6
Evo	p7
Flinders SMC	p8



DAINTREE SHOWER SCREEN

All measurements given in mm

Code	Size	RRP exc.GST	RRP inc. GST
KSSDA26CHCLS	900x900 - Chrome actual size 850x875	\$1,034.00	\$1,137.40
KSSDA40CHCLS	1000x1000 - Chrome actual size 950x975	\$1,066.00	\$1,172.60

Daintree shower systems are uniquely designed for the smaller bathroom, featuring two sliding doors; with entry from the front corner. The fully-framed design adds a modern, elegant look.

- Saves space with sliding doors
- Magnetic seals making it leak-proof
- Adjustment range allows for the perfect fit
- Pre-treated with Enduroshield, making it easy to clean
- Safety Glass

Height	2000 mm
Glass Thickness	6 mm
Colours	Chrome
Material	Toughened safety glass to standards
Tiled Floor Suitable	Yes
Alcoves Suitable	No

Base Compatibility

Daintree	p5
Barossa	p7
Flinders SMC	p8



SHOWER SCREENS



DAINTREE CURVED SHOWER SCREEN

All measurements given in mm

Code	Size	RRP exc.GST	RRP inc. GST
SSDA89CHCLP	914x914 - Chrome actual size 855x880	\$1,202.00	\$1,322.20
SSDA99CHCLP	1000x1000 - Chrome actual size 950x975	\$1,236.00	\$1,359.60

Daintree shower systems are uniquely designed for the smaller bathroom, featuring two sliding doors; with entry from the front corner. The fully-framed design adds a modern, elegant look.

- Saves space with sliding doors
- Magnetic seals making it leak-proof
- Adjustment range allows for the perfect fit
- Pre-treated with Enduroshield, making it easy to clean
- Safety Glass

Height	2000 mm
Glass Thickness	6 mm
Colours	Chrome
Material	Toughened safety glass to standards
Tiled Floor Suitable	Yes
Alcoves Suitable	No
Base Compatibility	
Flinders Polymarble	p8
Evo	p9



BAROSSA SLIDER SHOWER SCREEN

All measurements given in mm

FRONT PANEL SET

Code	Size	RRP exc.GST	RRP inc. GST
SSBA34CHCLS	1200 - Chrome Alcove (actual size 1155 - 1175) Return (actual size 1170 - 1195)	\$693.00	\$762.30
SSBA34MBCLS	1200 - Black Alcove (actual size 1155 - 1175) Return (actual size 1170 - 1195)	\$706.00	\$776.60
SSBA37CHCLS	1500 - Chrome Alcove (actual size 1435 - 1455) Return (actual size 1450 - 1475)	\$938.00	\$1,031.80

RETURN PANEL SET

Code	Size	RRP exc.GST	RRP inc. GST
SSBA26CHCLR	900 - Chrome Return Panel (actual size 860 - 885)	\$476.00	\$523.60
SSBA26MBCLR	900 - Black Return Panel	\$484.00	\$532.40

With 8mm toughened glass, easy to clean Enduroshield™ and a new slim design, the Barossa Slider is the king of shower screens.

- Pre-treated with Enduroshield, making it easy to clean
- 8mm toughened glass for increased safety and durability
- Adjustment range allows for the perfect fit

Height	2000 mm
Glass Thickness	8 mm
Colours	Chrome
Material	Toughened safety glass to AU Standards AS/NZS 2208:1996
Tiled Floor Suitable	Yes
Alcoves Suitable	Yes
Base Compatibility	
Daintree	p5
Barossa	p7
Flinders SMC	p8



SHOWER SCREENS



BAROSSA PIVOT SEMI-FRAMELESS SHOWER SCREEN

All measurements given in mm

FRONT PANEL SET

Code	Size	RRP exc.GST	RRP inc. GST
KSSPV26CHP	900 (actual size 860 - 885)	\$913.00	\$1,004.30
KSSPV40CHP	1000 (actual size 960 - 985)	\$947.00	\$1,041.70
KSSPV34CHP	1220 (actual size 1180 - 1205)	\$1,027.00	\$1,129.70

RETURN PANEL SET

Code	Size	RRP exc.GST	RRP inc. GST
SSPV26CHR	900 (actual size 860 - 885)	\$500.00	\$550.00
SSPV40CHR	1000 (actual size 960 - 985)	\$528.00	\$580.80

Utilising a sleek and minimal wall profile, the Barossa Pivot shower screen is easy to install. The Barossa Pivot shower screen features 8mm glass for increased safety and durability and suits the Daintree and Barossa shower bases and tiled floors.

- Toughened safety glass
- Adjustment range allows for the perfect fit
- Fully reversible

Height	2000 mm
Glass Thickness	8 mm
Colours	Chrome
Material	Toughened safety glass to AU Standards AS/NZS 2208:1996
Tiled Floor Suitable	Yes
Alcoves Suitable	No
Base Compatibility	
Daintree	p5
Barossa	p7
Flinders SMC	p8



BAROSSA PIVOT FRAMELESS SHOWER SCREEN

All measurements given in mm

FRONT PANEL SET

Code	Size	RRP exc.GST	RRP inc. GST
KSSPP26CHP	900 (actual size 860)	\$913.00	\$1,004.30
KSSPP40CHP	1000 (actual size 960)	\$947.00	\$1,041.70
KSSPP34CHP	1220 (actual size 1180)	\$1,027.00	\$1,129.70

RETURN PANEL SET

Code	Size	RRP exc.GST	RRP inc. GST
SSPP26CHR	900 (actual size 860)	\$500.00	\$550.00
SSPP40CHR	1000 (actual size 960)	\$528.00	\$580.80

Utilising a sleek and minimal wall profile, the Barossa Pivot shower screen is easy to install. The Barossa Pivot shower screen features 8mm glass for increased safety and durability and suits the Daintree and Barossa shower bases and tiled floors.

- Toughened safety glass
- Fully reversible

Height	2000 mm
Glass Thickness	8 mm
Colours	Chrome
Material	Toughened safety glass to AU Standards AS/NZS 2208:1996
Tiled Floor Suitable	Yes
Alcoves Suitable	No
Base Compatibility	
Daintree	p5
Barossa	p7
Flinders SMC	p8



SHOWER SCREENS



CORSICA SLIDER SHOWER SCREEN

All measurements given in mm

FRONT PANEL SET

Code	Size	RRP exc. GST	RRP inc. GST
SSD534CHS	1220 - Chrome (actual size 1180 - 1225)	\$1,185.00	\$1,303.50
SSD534BLS	1220 - Black (actual size 1180 - 1225)	\$1,236.00	\$1,359.60
SSD537CHS	1500 - Chrome (actual size 1460 - 1505)	\$1,364.00	\$1,500.40
SSD537BLS	1500 - Black (actual size 1460 - 1505)	\$1,423.00	\$1,565.30

RETURN PANEL SET

Code	Size	RRP exc. GST	RRP inc. GST
SSD526CHR	900 - Chrome (actual size 860 - 905)	\$489.00	\$537.90
SSD526BLR	900 - Black (actual size 860 - 905)	\$508.00	\$558.80
SSD540CHR	1000 - Chrome (actual size 960 - 1005)	\$521.00	\$573.10
SSD540BLR	1000 - Black (actual size 960 - 1005)	\$541.00	\$595.10

With its European frame design, smooth rollers and option of a matte black or chrome finish, the Corsica Slider shower screen makes a bold statement in any bathroom.

- Pre-treated with Enduroshield, making it easy to clean
- Toughened safety glass
- Fully reversible

Height	2000 mm
Glass Thickness	8 mm
Colours	Chrome Black
Material	Toughened safety glass to AU Standards AS/NZS 2208:1996
Tiled Floor Suitable	Yes
Alcoves Suitable	Yes
Base Compatibility	
Daintree	p5
Barossa	p7
Flinders SMC	p8



FLINDERS SHOWER PANEL

All measurements given in mm

Code	Size	RRP exc. GST	RRP inc. GST
SSSP26CHCLP	2000(H) x 865 - 890mm	\$599.00	\$658.90
SSSP34CHCLP	2000(H) x 1165 - 1190mm	\$708.00	\$778.80

The Flinders Shower Panel is fully reversible for placement on the left or right. It features an acrylic arm for support and 8mm toughened glass.

- Creates a walk-in shower effect
- Toughened safety glass
- Fully reversible screen

Height	2000 mm
Glass Thickness	8 mm
Colours	Chrome
Material	Toughened safety glass to AU Standards AS/NZS 2208:1996
Tiled Floor Suitable	Yes
Alcoves Suitable	No



SHOWER SCREENS



CORSICA BI-FOLD SHOWER SCREEN

All measurements given in mm

RH HINGES DOOR SET

Code	Size	RRP exc.GST	RRP inc. GST
SSD526RCHB	900 - Chrome (actual size 860 - 905)	\$1,015.00	\$1,116.50
SSD526RBLB	900 - M.Black (actual size 860 - 905)	\$1,060.00	\$1,166.00
SSD540RCHB	1000 - Chrome (actual size 960 - 1005)	\$1,056.00	\$1,161.60
SSD540RBLB	1000 - M.Black (actual size 960 - 1005)	\$1,100.00	\$1,210.00

LH HINGES DOOR SET

Code	Size	RRP exc.GST	RRP inc. GST
SSD526LCHB	900 - Chrome (actual size 860 - 905)	\$1,015.00	\$1,116.50
SSD526LBLB	900 - M.Black (actual size 860 - 905)	\$1,060.00	\$1,166.00
SSD540LCHB	1000 - Chrome (actual size 960 - 1005)	\$1,056.00	\$1,161.60
SSD540LBLB	1000 - M.Black (actual size 960 - 1005)	\$1,100.00	\$1,210.00

RETURN PANEL SET

Code	Size	RRP exc.GST	RRP inc. GST
SSD526CHR	900 - Chrome (actual size 860 - 890)	\$489.00	\$537.90
SSD526BLR	900 - M.Black (actual size 860 - 890)	\$508.00	\$558.80
SSD540CHR	1000 - Chrome (actual size 960 - 990)	\$521.00	\$573.10
SSD540BLR	1000 - M.Black (actual size 960 - 990)	\$541.00	\$595.10

Designed with the small bathroom in mind the Corsica Bi-Fold shower screen combines luxury and practicality. With its European inspired frame design, unique bi-fold system and 8mm toughened glass, this clever system is like no other.

- Pre-treated with Enduroshield, making it easy to clean
- Available in Chrome or Matte Black
- Unique left hand or right hand bi-folding doors, perfect for small bathrooms
- Safety Glass

Height	2000 mm
Glass Thickness	8 mm
Colours	Chrome Matte Black
Material	Toughened safety glass to AU Standards AS/NZS 2208:1996
Tiled Floor Suitable	Yes
Alcoves Suitable	Yes
Base Compatibility	
Daintree	p5
Barossa	p7
Flinders SMC	p8



Image shows RH Opening screen.



Image shows LH Opening screen.

SHOWER WALLS

STANDARD SHOWER WALL

All measurements given in mm

2000 mm HEIGHT

Code	Size	RRP exc.GST	RRP inc. GST
WS13WHPO	900x2000 White 1-sided (Actual 883)*	\$305.00	\$335.50
WS16WHPO	820x820x2000 White 2-sided (Actual 785x785)*	\$488.00	\$536.80
WS26WHPO	900x900x2000 White 2-sided (Actual 883x883)*	\$480.00	\$528.00
WS29WHPO	1000x1000x2000 White 2-sided (Actual 983x983)*	\$554.00	\$609.40
WS34WHPO	1200x900x2000 White 2-sided (Actual 1195x883)*	\$590.00	\$649.00
WS37WHPO	1500x900x2000 White 2-sided (Actual 1483x883)*	\$666.00	\$732.60

Please note the below 3-sided shower wall sizes fit only Flinders SMC shower bases:

WU41WHPO	900 x 1200 x 900 x 2000 White 3-sided (Actual 887 x 1180 x 887)*	\$832.00	\$915.20
WH28WHPO	900x900x900x2000 White 3-sided (Actual 888 x 874 x 888)*	\$657.00	\$722.70

Custom wall options available upon request.

*Combined measurements cannot exceed 3000x2000 mm.

Marbletrend's acrylic shower walls are perfect for DIY as they are easy to install, fully reversible and feature a folded sheet, rather than a joined sheet. The walls feature Antibac® antimicrobial protection minimising the growth of bacteria in the shower, ensuring they are effortless to keep clean.

- Antibac® antimicrobial protection easy to clean
- Simple to cut, trim and add tapholes, easy installation
- Durable – scratch and crack resistant
- Adhesive included

Height	2000 mm
Colours	White
Material	Sanitary grade acrylic with ABS backing

* Measured Externally



KIMBERLEY SHOWER WALL

All measurements given in mm

1830 mm HEIGHT

Code	Size	RRP exc.GST	RRP inc. GST
WK26WHP	900x900 White 2-sided (Actual 883x883)	\$474.00	\$521.40
WK29WHP	1000x1000 White 2-sided (Actual 983x983)	\$509.00	\$559.90

Marbletrend's Kimberley shower wall is easy to install, fully reversible and includes a specifically formulated adhesive. The acrylic sheet features Antibac® antimicrobial protection minimising the growth of bacteria in the shower, ensuring the Kimberley shower wall is effortless to keep clean.

- Simple to cut, trim and add tapholes, easy installation
- Durable – scratch and crack resistant
- Antibac® antimicrobial protection, easy to clean

Height	1830 mm
Colours	White
Material	Sanitary grade acrylic with ABS backing



PRODUCT CARE

Vitreous China Appliances

Vitreous china toilets and basins can be cleaned using mild detergent and warm water with a soft sponge. Avoid the use of harsh and abrasive cleaners as these may scratch the glaze surface.

The bowl should be regularly cleaned using a toilet brush and a proprietary bowl cleanser.

Toilet Seats and Plastic Cisterns

These plastic items can be cleaned using mild detergent and warm water with a soft sponge. Do not use abrasive-type cleaners as these will remove the smooth glossy surface of the plastic.

Care should be taken to avoid staining with household cleaners, bleach, solvents, cosmetics and medicines - any spills should be cleaned up immediately to minimise any discoloration or etching effects to the plastic surface.

Minor scratches may be able to be polished out by carefully using auto cutting compound and polish on the plastic surface. This treatment can also be tried to remove the marks left by minor burns.

Do not use in-cistern sanitizers as these can affect the life and performance of the flush valve seals.

Periodically check and tighten seat hinge fixings.

Bathroom Furniture

The best method of maintaining the glossy finish is simply to wipe over with a clean, soft cloth. It is important that no abrasive cleaners or wax-based creams are used as this can result in a build-up of deposits/scratches that will detract from the appearance. Avoid contact with hard, sharp objects. Should scratches occur on gloss lacquered cabinets, fine marks can be removed using a cutting compound normally used for car re-treatment, followed by a car polish and a clean, soft cloth. In case of spilling any chemicals such as hair lacquer, after shave lotion, nail polish and remover, white spirit and insecticides, remove any residual immediately by washing the product.

Steel Baths

Enamelled steel baths can be cleaned using mild detergent and warm water with a soft sponge. If accidental abrasions occur, the surface brilliance can be restored with a silicon-based polish.

Proprietary porcelain enamel cleaners may be used but any residue should be thoroughly rinsed off afterwards.

Acrylic Baths and Shower Walls

Hot water in contact with this product must not exceed 55°C.

The surface of this base will resist surface build-up. However, to preserve its high gloss it may be cleaned with a soft cloth using warm soapy water or household detergent. Avoid all forms of abrasive. If accidental abrasions occur the surface brilliance can be restored by polishing with "Marbletrend Ultra Gloss" or similar silicone-based polish.

Polymarble, SMC & Acrylic Shower Bases

Hot water in contact with this product must not exceed 55°C.

The surface of this base will resist surface build-up. However, to preserve its high glossy finish it may be cleaned with a soft cloth using warm soapy water or household detergent. Avoid all forms of abrasive. If accidental abrasions occur, the surface brilliance can be restored with a silicon-based polish.

Shower Screens

Shower screens are treated with EnduroShield®

easy-to-clean glass surface treatment. Please follow the care instructions affixed to the door panel to ensure that your treatment is long lasting.

After use, the shower should be cleaned with a mild detergent and water. This is particularly important in hard water districts where insoluble lime salts may be deposited and allowed to build up. Abrasive cleaners should not be used.

Care should be taken to avoid contact with strong chemicals such as organic solvents and strippers.

Tapware & Bathroom Accessories

Never use harsh detergents or abrasive cleaners, as these can scratch the surface. Where your tapware/accessories remain dry in use, a soft cloth can be used to remove surface dust. Alternatively, a wipe over with warm soapy water is all that is required to maintain the finish in perfect condition for a lifetime of use. Use of wax based furniture cream should be avoided as these can result in a buildup of deposits, which could affect the appearance.

Spout aerators should be removed and cleaned periodically (the frequency will be determined by the water quality).

JohnsonSuisse

BATHROOM PRODUCTS AUSTRALIA PTY LTD

ABN 87 079 297 617

All sales and product enquiries 1300 717 717

bpa.info@johnsonsuiss.com.au

Head Office / Sydney Showroom
2/97 Banksia Street, Botany NSW 2019

johnsonsuiss.com.au





COMMERCIAL

Inclusion is at the heart of Johnson Suisse. our human approach to design within the bathroom space, drives us to find universal solutions to suit everyone's needs.



JohnsonSuisse
Bathroom Solutions

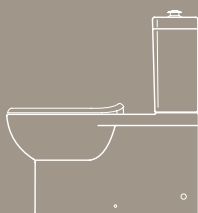

Healthcare



Childcare

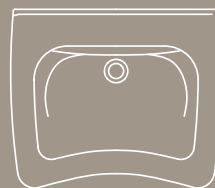

Hospital



AMBULANT TOILETS



VENEZIA AMBULANT

Code	RRP (exc. GST)	RRP (inc. GST)
JTTV301.J2371.101	\$733.00	\$806.30

- Modern style flush to wall vitreous china toilet suite
- Efficient rimless design for hygienic flushing
- Ambulant Compliant (to AS1428.1) flush to wall vitreous china toilet suite
- Efficient rimless design for hygienic flushing
- Cistern with concealed back entry water inlet
- Soft-close, quick release toilet seat made of Duroplast (Urea) material
- S or p trap configuration installation
- Variable S Trap pan connector (90-190mm set out)
- WELS 4 Star, 4.5/3.1L (3.4L average flush) L06869

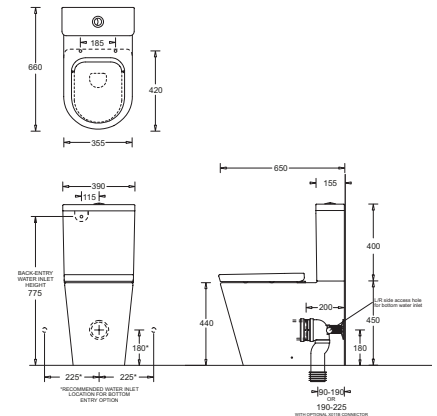

Optional Parts (not included)

Anti Vandal Fitting XJ122A	\$63.00	\$69.30
----------------------------	---------	---------

EMILIA XTRA (RIMLESS)

Code	RRP (exc. GST)	RRP (inc. GST)
JTTE401.402.X011H	\$609.00	\$669.90

- Contemporary FTW, CC, Rimless, vitreous china toilet suite
- Extra height and short projection makes it suitable for people with ambulant limitations (AS1428.1 compliant)
- Supplied with soft close seat as standard
- 4 Star dual flush efficiency
- Concealed back entry water inlet.
- Left/right hand bottom entry conversion valve available
- Adjustable S connector supplied for 90-140mm set out
- WELS 4 Star, 4.6/3.1L (3.4 average flush) L06639

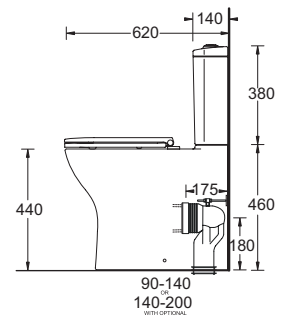

Optional Parts (not included)

Anti Vandal Fitting XJ122A	\$63.00	\$69.30
Adjustable S connector for 140-200mm set out		
X011B	\$67.00	\$73.70

PLAZA DELUXE VC AMBULANT

Code	RRP (exc. GST)	RRP (inc. GST)
Single Flap Seat J2031.J2201W.SF	\$932.00	\$1,025.20
Double Flap Seat J2031.J2201W	\$933.00	\$1,026.30

- Functional stylish design with extra-height concealed outlet S pan matched with a VC cistern suitable for assisted living (AS1428.1 Ambulant compliant)
- White soft close seat with fitted plastic link
- Suitable for new or replacement installations
- Flexible S Trap set out range 140-160mm
- L/R Adjustable water inlet
- WELS 4 Star, 4.5/3.1L (3.4 average flush) L06685

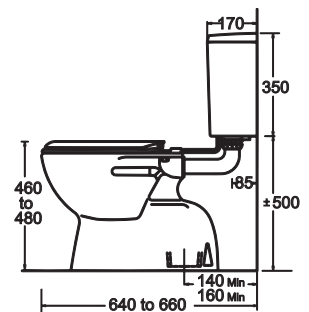

Optional Parts (not included)

Anti Vandal Fitting XJ122B	\$66.00	\$72.60
----------------------------	---------	---------

AMBULANT TOILETS



TOLEDO XTRA (RIMLESS)

Code	RRP (exc. GST)	RRP (inc. GST)
JTTT401.JTTT402.E101	\$668.00	\$734.80

- Smartly styled flush to wall close coupled vitreous china toilet suite
- Rimless flushing system - efficient and easy to clean
- Supplied with Esti soft close quick release seat MSEE101
- Can be used in ambulant-assisted living installations with the increased seat height for comfortable use (AS1428.1 Ambulant compliant)
- Concealed back entry water inlet
- Optional bottom entry water inlet available
- Adjustable S connector supplied for 90-175mm set out
- WELS 4 Star, 4.5/3L (3.2 average flush) L06645

Optional Parts (not included)

Anti Vandal Fitting XJ122A	\$63.00	\$69.30
Adjustable S connector for 175-210mm set out X011B	\$67.00	\$73.70

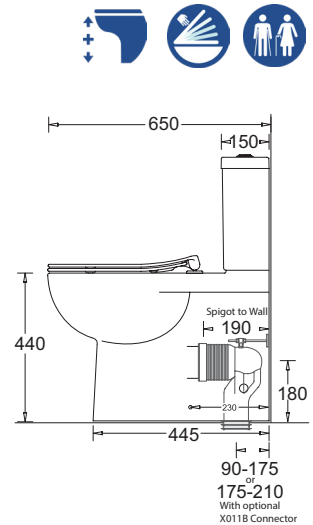

TOLEDO XTRA ECONOFLUSH (RIMLESS)

Code	RRP (exc. GST)	RRP (inc. GST)
JTTT601.MSEE101	\$452.00	\$497.20

- Rimless wall-faced pan with a concealed in wall cistern
- This wall-faced pan with in wall cistern combination is suitable for commercial or domestic applications
- Extra-height pan suitable for assisted living/ambulant installations
- Optional Vandal-resistant seat available
- Selection of cistern actuator buttons available (see Pg 35)
- Minimum 90mm cavity depth
- S trap set out 90-120mm P trap set out 180mm
- WELS 4 Star, 4.6/3L (3.3 average flush) L06670
- Pneumatic Push Buttons for Econoflush In-Wall cistern - see page p.34

Optional Parts (not included)

Code	RRP (exc. GST)	RRP (inc. GST)
Econoflush In-Wall Cistern J2982A	\$488.00	\$536.80
Pneumatic button - White JB92W	\$246.00	\$270.60
Pneumatic button - Black JB92BLK	\$246.00	\$270.60
Pneumatic button - Chrome JB92C	\$246.00	\$270.60
Pneumatic button - Matte JB92M	\$246.00	\$270.60
Remote Installation Kit JB92K	\$197.00	\$216.70

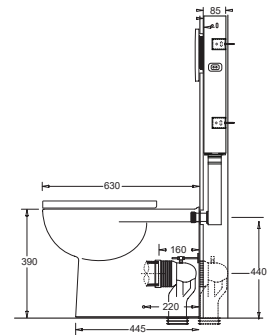

AMBULANT ACCESSORIES

AMBULANT GRAB RAIL 90°

Code	RRP (exc. GST)
BR4545 Square	\$81.00

- Functional grabrail set can be installed compliant with AS1428.1
- Satin finished 32mm diameter stainless steel
- Concealed wall fixings

Compliant with AS1428.1 Design for Access and Mobility

Note: GST Exempt



SPECIAL NEEDS TOILETS



LIFE ASSIST FTW RIMLESS SPECIAL NEEDS TOILET SUITE

Code	RRP (exc. GST)	RRP (inc. GST)
Blue Seat		
JTTLA401.J2750SNB	\$1,434.00	\$1,577.40
White Seat		
JTTLA401.J2750SNW	\$1,434.00	\$1,577.40
Grey Seat		
JTTLA401.J2750SNG	\$1,434.00	\$1,577.40

- Flush to wall toilet suite designed for special needs applications
- Extended WC pan for wheelchair side access - AS1428.1 compliant
- Raised flush buttons (blue) for ease of operation
- Rimless bowl design with antimicrobial Nano Glaze for hygienic flushing
- Special needs seat (blue or grey) with lateral stabilisers
- Cistern with concealed back entry water inlet
- Variable S trap pan connector (100-300mm set out)
- WELS 4 Star, 4.3/2.9L (3.2L average flush) L06864

Special Note: For compliance with AS1438.1 the seat is available in grey or blue colour to provide contrast for vision impaired individuals. The seat also has lateral stabiliser fitted for people with ambulatory limitations and there is no seat lid. Note that the design of the installation must comply with AS1428.1(2009)-Design for access and mobility.

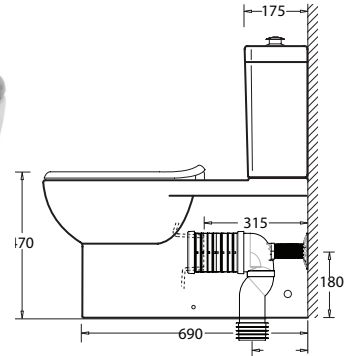

LIFE ASSIST WF S/P TRAP

Code	RRP (exc. GST)	RRP (inc. GST)
Blue Seat		
J2775.RB6044B	\$1,439.00	\$1,582.90
White Seat		
J2775.RB6044W	\$1,439.00	\$1,582.90
Grey Seat		
J2775.RB6044G	\$1,439.00	\$1,582.90

- Modern wall-faced pan matched with a concealed in-wall cistern
- Extra-height WC pan with blue / grey / white seat and flush button options
- Compliant with appropriate requirements of AS1428.1 for disabled and assisted living
- Remote pneumatic cistern actuation - buttons can be connected via air tube up to 4m long with optional Remote Installation Kit (JB92K)
- Suitable for commercial or domestic installations
- WC Pan - WELS 4 Star, 4.6/3.0L (3.3L average flush) L06745

Optional Parts (not included)

Econoflush In-Wall Cistern		
J2982A	\$488.00	\$536.80
Raised Circle Button (Matt Chrome) JB90C	\$246.00	\$270.60
Raised Circle Button (Blue) JB90B	\$246.00	\$270.60
Remote Install Kit Pneumatic Button JB92K	\$197.00	\$216.70
Assist Backrest p.5		

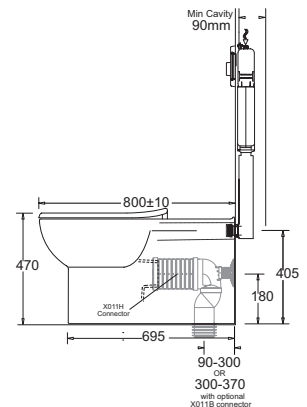

SPECIAL NEEDS TOILETS



PLAZA ASSIST DELUXE VC S TRAP

Code	RRP (exc. GST)	RRP (inc. GST)
Blue Seat		
J2031.J2201SNB	\$999.00	\$1,098.90
White Seat		
J2031.J2201SNW	\$999.00	\$1,098.90
Grey Seat		
J2031.J2201SNG	\$999.00	\$1,098.90

- Functional stylish design with extra-height concealed outlet S pan and wall mounted vitreous china cistern
- Blue/grey/white seat and raised flush buttons - compliant with appropriate requirements of AS1428.1 for special needs or ambulant installations
- L/R Adjustable water inlet
- Suitable for new or replacement installations
- WELS 4 Star, 4.5/3.1L (3.4 average flush) L06685

Optional Parts (not included)

Assist Backrest BR1002	\$375.00
------------------------	----------

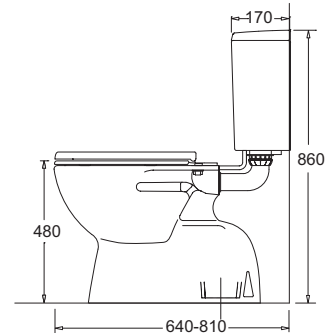

SELECT ASSIST DELUXE PLASTIC S TRAP

Code	RRP (exc. GST)	RRP (inc. GST)
Blue Seat		
J2031.RG21016SNB	\$749.00	\$823.90
White Seat		
J2031.RG21016SNW	\$749.00	\$823.90
Grey Seat		
J2031.RG21016SNG	\$749.00	\$823.90

- Functional stylish design with extra-height concealed outlet S pan and wall mounted plastic cistern
- Blue/grey/white seat and raised flush buttons - compliant with appropriate requirements of AS1428
- L/R Adjustable water inlet
- J2031 - WELS 4 Star, 4.5/3.1 (3.4 average flush) L06671
- RG21016 - WELS 4 Star, 4.7/2.8L (3.2L average flush) L07697

Optional Parts (not included)

Assist Backrest BR1002	\$375.00
------------------------	----------

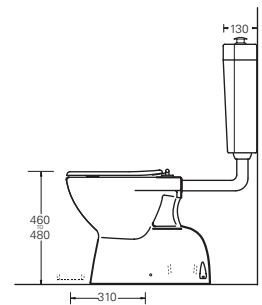

ASSIST ACCESSORIES

ASSIST BACKREST

Code	RRP (exc. GST)
Assist Backrest Support BR1002	\$375.00
Assist Backrest 680mm for SS Panel With Legs BR1003.BRX02	\$419.00

- Universal design that complies with AS1428.1 when installed to instructions
- Quality 32mm stainless steel frame with cushion pad
- Robust concealed wall fixings
- Can be used with all Assist toilets
- Compliant with AS1428.1 Design for Access and Mobility

Note: GST Exempt

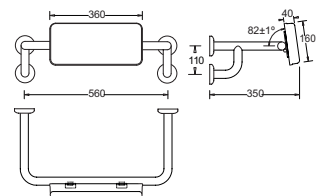

ASSIST ACCESSORIES

ASSIST GRAB RAIL

Straight Grab Rails

Code	RRP (exc. GST)
BR1030 (300mm)	\$51.00
BR1060 (600mm)	\$59.00
BR1090 (900mm)	\$71.00

90° Grab Rail 950 x 600

BR9460L (LHS)	\$146.00
BR9460R (RHS)	\$146.00

140° Grab Rail 850 x 700

BR8570L (LHS)	\$146.00
BR8570R (RHS)	\$146.00

Straight Grab Rails

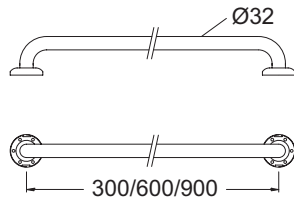

90° Grab Rail 950 x 600

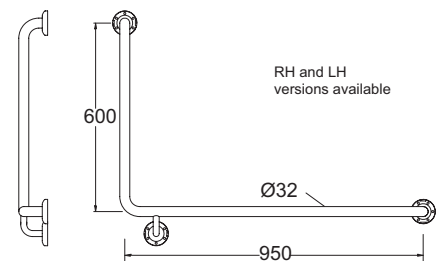

90° Corner Wrap Around Grab Rail for use with in-wall cisterns

BR1060.980L (LHS)	\$228.00
BR1060.980R (RHS)	\$228.00

140° Corner Wrap Around Grab Rail for use with in-wall cisterns

BR1100.9070L (LHS)	\$228.00
BR1100.9070R (RHS)	\$228.00

Shower Grab Rails 700 x 1100

BR7011L (LHS)	\$146.00
BR7011R (RHS)	\$146.00

140° Grab Rail 850 x 700

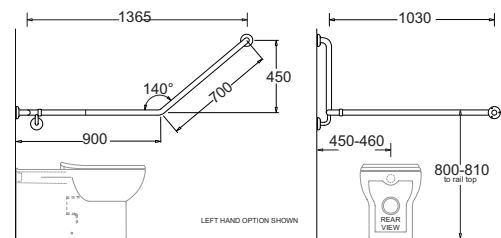

- Compliant with AS1428.1 - Design for Access and Mobility
- Satin finished 32mm diameter stainless steel
- Concealed wall fixings
- Available in left or right handed options (as user sits on toilet / shower seat)

Note: GST Exempt

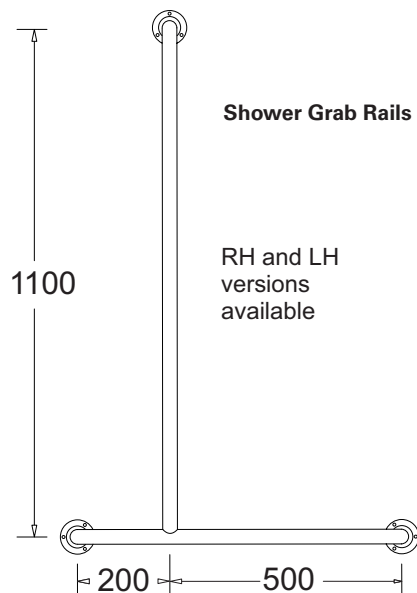

140° Corner Wrap Around Grab Rail for use with in-wall cisterns

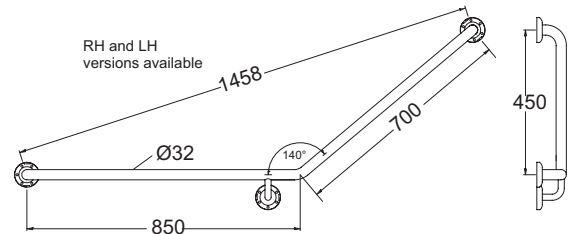

90° Corner Wrap Around Grab Rail for use with in-wall cisterns

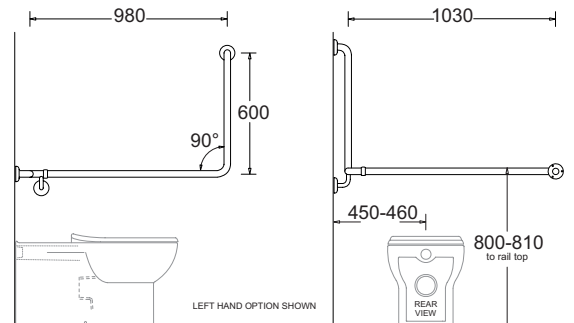

ASSIST ACCESSORIES

LIFE ASSIST 3 FUNCTION GRAB RAIL SHOWER SET

Code	RRP (exc. GST)
BR7011L.JTFN (Left)	\$425.00
BR7011R.JTFN (Right)	\$425.00

- Available in left or right handed options
- AS1428.1 - Disabled compliant
- Concealed wall fixings
- Satin finished 32mm diameter stainless steel
- It includes the shower set JTFN18
- Wall elbow with back-flow prevention device
- WELS 3 Star, 8.5L/min. S14882

Note: GST Exempt

Spare Parts	RRP (exc. GST)
Anti-Vandal Hand Shower Holder/Slider CAC02	\$56.00



Right hand product shown



LIVING 3 FUNCTION GRAB RAIL SHOWER SET

Code	RRP (exc. GST)
BR1090.JTFN (900mm)	\$327.00

- The 900mm variant is AS1428.1 - Disabled compliant
- Concealed wall fixings
- It includes the shower set JTFN18
- Wall elbow with back-flow prevention device
- WELS 3 Star, 8.5L/min. S14882

Spare Parts	RRP (exc. GST)
Anti-Vandal Hand Shower Holder/Slider CAC02	\$56.00

Note: GST Exempt



ASSIST SHOWER SEAT

Code	RRP (exc. GST)
JSS001	\$712.00

Universal design suitable for assisted living installations

- Quality stainless steel frame construction with durable selfdraining plastic seat
- Folds flat to wall when not required
- Robust wall fixings
- Compliant with Disabled sections of AS1428.1 - Design for access and mobility

Note: GST Exempt

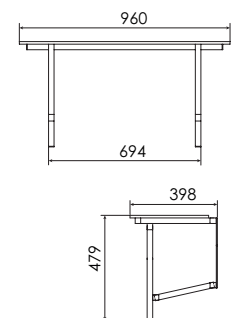

ASSIST WALL BASINS



QUADO ASSIST 450

Code	RRP (exc. GST)	RRP (inc. GST)
Basin Incl 40/32 JS Bottle Trap J3160.1.BT1.PW1	\$491.00	\$540.10

- Contemporary rectangular basin
- Suitable for commercial and domestic applications
- Wide soap platform
- Supplied with Chrome Pop-up Waste 32mm
- Capacity 4.0L
- 1 Taphole

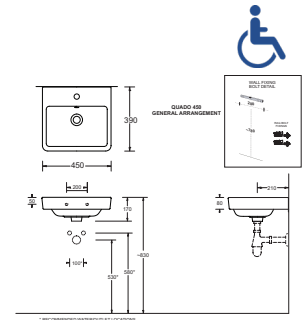

QUADO ASSIST 550

Code	RRP (exc. GST)	RRP (inc. GST)
Basin Incl Standard Shroud J3162.1.J3168.PW1	\$483.00	\$531.30
Basin Incl 40/32 JS Bottle Trap J3162.1.BT1.PW1	\$531.00	\$584.10

- Contemporary styled rectangular basin
- Mid-sized
- Wide soap platform
- Supplied with Chrome O/Flow Plug & Waste
- Compliant with AS1428.1 Design for Access and Mobility
- 1 Taphole

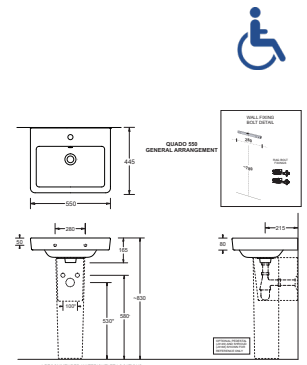

LIFE II

Code	RRP (exc. GST)	RRP (inc. GST)
Basin Incl. Shroud JBLSL849.1.852.PW1	\$457.00	\$502.70
Basin Incl. 40/32mm JS Bottle Trap JBLSL849.1.BT1.PW1	\$529.00	\$581.90

- Contemporary vitreous china wall basin
- Wide soap platform
- Single taphole for mixer tap
- Features modern style
- Capacity 8.3L
- 1 Taphole

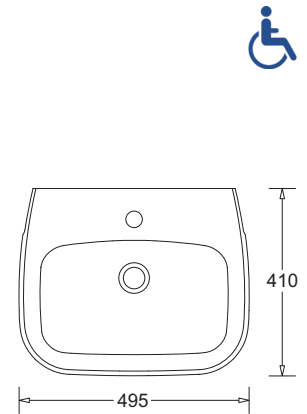

EMILIA ASSIST 550 WB

Code	RRP (exc. GST)	RRP (inc. GST)
Basin Incl Standard Shroud J3142.1.J3168.PW1	\$501.00	\$551.10
Basin Incl 40/32 JS Bottle Trap J3142.1.BT1.PW1	\$548.00	\$602.80

- Contemporary standard basin
- Mid-sized
- Wide soap platform area
- Supplied with Chrome O/Flow Plug & Waste
- Compliant with AS1428.1 Design for Access and Mobility
- 1 Taphole

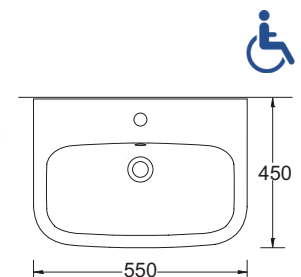



ASSIST WALL BASINS

LUCCA SHELF LH/RH

Code	RRP (exc. GST)	RRP (inc. GST)
0 Taphole Basin incl Standard Shroud		
Left Hand Shelf		
J3170L.0.N.J3168.PW1	\$636.00	\$699.60
Right Hand Shelf		
J3170R.0.N.J3168.PW1	\$636.00	\$699.60
0 Taphole Basin Incl 40/32 JS Bottle Trap		
Left Hand Shelf		
J3170L.0.N.BT1.PW1	\$684.00	\$752.40
Right Hand Shelf		
J3170R.0.N.BT1.PW1	\$684.00	\$752.40
1 Taphole Basin Incl Standard Shroud		
Left Hand Shelf		
J3170L.1.N.J3168.PW1	\$636.00	\$699.60
Right Hand Shelf		
J3170R.1.N.J3168.PW1	\$636.00	\$699.60
1 Tapware Basin Incl 40/32 JS Bottle Trap		
Left Hand Shelf		
J3170L.1.N.BT1.PW1	\$684.00	\$752.40
Right Hand Shelf		
J3170R.1.N.BT1.PW1	\$684.00	\$752.40

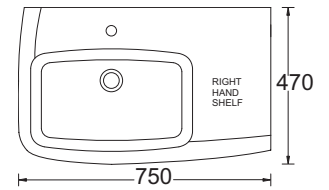
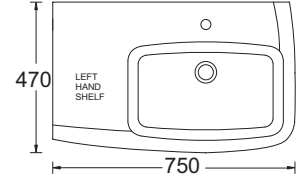

- Large wall basin
- Shelf on left or right side
- Wide soap platform area
- Compliant with AS1428.1 Design for Access and Mobility

ASSIST SEMI-RECESSED BASINS

AVON

Code	RRP (exc. GST)	RRP (inc. GST)
J3010.1.PW2	\$199.00	\$218.90
J3010.1.BT1.PW1 - W/ Bottle Trap	\$441.00	\$485.10

- Traditional Oval form semi-recessed basin
- Suitable for commercial and domestic applications
- Mid-sized with generous bowl size
- Supplied with Plastic O/Flow Plug & Waste
- Capacity 4L
- 1 Taphole

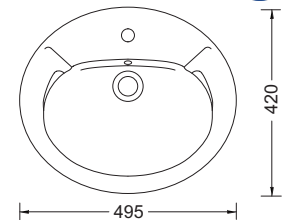

HEALTH CARE



TYPE A MEDICAL BASIN

Code	RRP (exc. GST)	RRP (inc. GST)
J3090.PW1	\$684.00	\$752.40

- Large custom shaped basin for hospital use
- Durable glaze finish
- No taphole or overflow
- Robust wall mountings with stainless steel wastesupport bracket
- Capacity 15L
- Supplied with PW1 Chrome O/Flow Plug & Waste 32/40mm

Suitable as a Type A - Large Clinical Staff Basin per Australasian Health Facility Guidelines: Part D

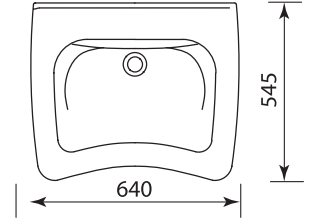

BOSTON TYPE B WALL BASIN CARE

Code	RRP (exc. GST)	RRP (inc. GST)
J3092.0.PW1 (0 Taphole)	\$684.00	\$752.40
J3092.1.PW1 (1 Taphole)	\$684.00	\$752.40

- Medium D-shaped basin for clinic use
- Durable, hygienic glaze finish
- 0/1 taphole option
- No overflow
- Robust wall mountings
- Supplied with PW1 Chrome O/Flow Plug & Waste 32/40mm included
- Capacity 13L

Optional Parts (not included)

Boston Shroud J3189	\$229.00	\$251.90
---------------------	----------	----------

Compliant with AS1428.1 Design for Access and Mobility. Suitable as a Type B - Medium Clinical Staff Basin per Australasian Health Facility Guidelines: Part D

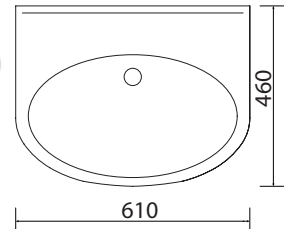

BOSTON TYPE C WALL BASIN CARE

Code	RRP (exc. GST)	RRP (inc. GST)
J3094.0.PW1 (0 Taphole)	\$470.00	\$517.00
J3094.1.PW1 (1 Taphole)	\$470.00	\$517.00

- D-shaped basin for clinic use
- Durable, hygienic glaze finish
- 0/1 taphole option
- No overflow
- Robust wall mountings
- Chrome O/Flow Plug & Waste 32/40mm included
- Capacity 10L

Optional Parts (not included)

Boston Shroud J3189	\$229.00	\$251.90
---------------------	----------	----------

Compliant with AS1428.1 Design for Access and Mobility. Suitable as a Type C - Non-Clinical Small/Medium Staff Hand Basin per Australasian Health Facility Guidelines: Part D

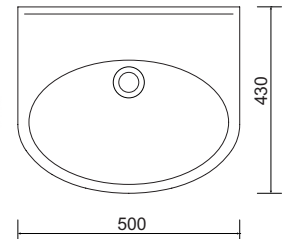

HEALTH CARE



LUCCA SHELF LH/RH

Code	RRP (exc. GST)	RRP (inc. GST)
1 Taphole no O/F Left Hand Shelf J3170L.1.N.PW1	\$443.00	\$487.30
Right Hand Shelf J3170R.1.N.PW1	\$443.00	\$487.30
0 Taphole no O/F Left Hand Shelf J3170L.0.N.PW1 (LH Shelf)	\$443.00	\$487.30
Right Hand Shelf J3170R.0.N.PW1 (RH Shelf)	\$443.00	\$487.30

- Large wall basin
- Shelf on left/right side
- Wide soap platform area
- Supplied with Chrome Pop-up Waste 32mm
- Capacity 6.6L (12L capacity for no overflow version)
- Compliant with Disabled sections of AS1428.1
- Design for Access and Mobility

Optional Parts (not included)

Standard Shroud J3168	\$193.00	\$212.30
-----------------------	----------	----------

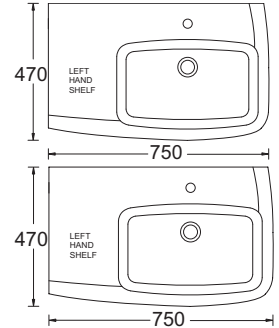

CLEANERS ROOM

CLEANER SINK

Code	RRP (exc. GST)	RRP (inc. GST)
G1500.PW4	\$1,167.00	\$1,283.70

- Functional cleaners sink designed specially for commercial applications
- Shown with buffer and grate
- Strong chrome plated pail support grating and durable rubber edge Buffer included
- Brackets and screw/bolt fixing included
- Requires 50mm waste fitting (not supplied)
- 560 x 425mm

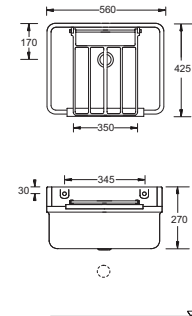

URINALS



VENEZIA URINAL

Code	RRP (exc. GST)	RRP (inc. GST)
JURV100	\$1,145.00	\$1,259.50

F&B

- Attractive yet functional compact wall-hung urinal
- Back water entry options
- Easy-fix sturdy mounting bracket and fixings
- Removable, vandal-resistant stainless steel waste dome
- Trap fitting included
- WELS 6 Star, 0.8L/Flush, U00476

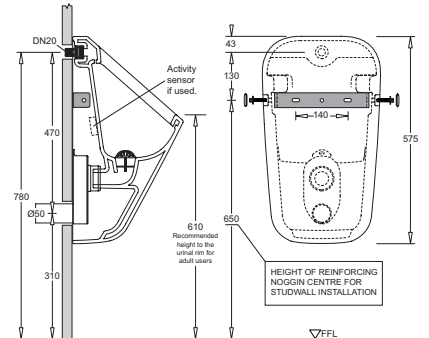

Optional Parts Back Entry (not included)

Code	RRP (exc. GST)	RRP (inc. GST)
JURS900	\$75.00	\$82.50

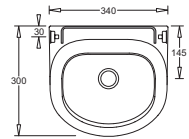

VENEZIA ELECTRONIC URINAL

Code	RRP (exc. GST)	RRP (inc. GST)
JURS400	\$580.00	\$638.00
JURV100.401	\$1,315.00	\$1,446.50
JURV100.400.401	\$1,895.00	\$2,084.50

JURS400 – Sentinel Urinal Flushing System - Rough in Kit (not Including Sensor)

- Integrated Stadium Mode reduces water consumption in highuse environment
- For use with back (concealed) water entry urinal
- Option stainless steel cover plate available (JUR900)
- WELS 6 Star 0.8L/flush. U00475



JURV100.401 – Venezia Urinal Fit - Off Kit

- Attractive and functional wall hung urinal (JURV100)
- Modern compact styling with simple easy - clean lines
- Suitable for back entry installation
- Includes trap fitting, vandal proof waste dome and Easi-fix mounting bracket and fixings
- WELS 6 Star 0.8L/Flush U00476



JURV100.400.401 – Venezia Urinal Suite With Sentinel Electronic Urinal Flushing System

- Attractive and functional wall hung urinal (JURV100)
- Stadium Mode reduces water usage during ultra-high use
- Includes trap fitting, vandal proof waste dome and Easi-fix mounting bracket and fixings.
- WELS 6 Star, 0.8L/Flush U00474



Optional Parts (not included)

Code	RRP (exc. GST)	RRP (inc. GST)
JURS900	\$75.00	\$82.50



URINALS



LIFE URINAL TOP ENTRY / BACK ENTRY

Code	RRP (exc. GST)	RRP (inc. GST)
Top Entry J6000	\$1,474.00	\$1,621.40
Back Entry J6010	\$1,474.00	\$1,621.40

Top Entry

- Practical wall-mounted single urinal
- Simple mounting with trap fitting provided
- Top water entry
- Can be connected to cistern or solenoid activated flushing systems
- WELS 4 Star, 1.5L/Flush U00430

Back Entry

- Practical wall-mounted single urinal
- Simple urinal mounting with waste trap fitting supplied
- Back water entry urinal
- WELS 4 Star, 1.5L/Flush U00428

Optional Parts Top Entry (not included)

Pull Chain Urinal Cistern RG21015PC	\$492.00	\$541.20
--	----------	----------

Optional Parts Back Entry (not included)

Urinal HF Electronic Valve J6200	\$1,681.00	\$1,849.10
-------------------------------------	------------	------------

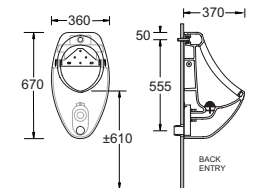
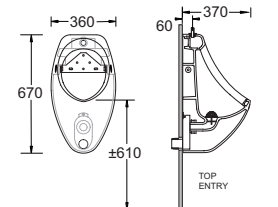

PULL CHAIN URINAL CISTERN

Code	RRP (exc. GST)	RRP (inc. GST)
RG21015PC	\$492.00	\$541.20

- Wall-mounted plastic cistern
- Pull-chain flushing activation
- Adjustable flush volume
- Connection for 19mm or 25mm urinal flush pipe
- WELS 3 Star, 1.5L U00432
- Sparge pipe not included

Optional Parts (not included)

Life Urinal - Top Entry J6000	\$1,474.00	\$1,621.40
-------------------------------	------------	------------

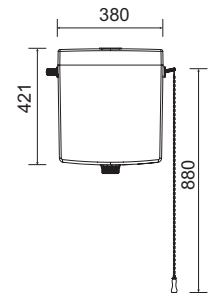

ELECTRONIC URINAL

Code	RRP (exc. GST)	RRP (inc. GST)
J6203A	\$1,489.00	\$1,637.90
J6010.J6206	\$1,780.00	\$1,958.00
J6010.J6200	\$3,155.00	\$3,470.50

J6203A – Electronic flush valve rough-in kit (Install prior to tiling)

- German engineered for a lifetime of reliable commercial use
- Integrated Stadium Mode reduces water consumption in highuse environment
- For use with back (concealed) water entry urinal
- Option stainless steel cover plate available (J6209)
- WELS 4 Star, 1.5L/Flush U00430

J6010.J6206 – Life Back Entry Electronic Urinal Fit - Off Kit

- Attractive and functional wall hung urinal (J6010)
- Includes Schell Liquid - Activated Sensor and adhesive (J6206A)
- Modern styling with simple easy - clean lines
- Suitable for back entry installation
- Includes trap fitting, vandal proof waste dome and Easi-fix mounting bracket and fixings

J6010.J6200 – Life Back Entry Electronic Urinal Complete Suite

- Attractive and functional wall hung urinal (J6010)
- Advanced German engineered for a lifetime of reliable commercial use
- Stadium Mode reduces water usage during ultra-high use
- Stagnation Flush improves hygiene, product lifespan, and cleaning time by preventing build up of harmful waste
- Includes Schell Liquid - Activated Sensor and adhesive (J6206A) and Schell Electronic rough-in kit (J6203A)
- Includes trap fitting, vandal proof waste dome and Easi-fix mounting bracket and fixings.

Optional Parts (not included)

SS Valve Cover Plate J6209	\$321.00	\$353.10
Life Urinal - Back Entry J6010	\$1,474.00	\$1,621.40



LAB SINKS

UTILITY SINK SMALL

Code
C5201.PW2

RRP (exc. GST)	RRP (inc. GST)
\$660.00	\$726.00

- Rectangular, drop-in vitreous china laboratory sink
- Durable glaze finish
- Standard overflow
- Plastic O/Flow Plug & Waste 32/40mm included (Acid resistant)
- Nominal bowl capacity 23L

Optional (not included)

Undermount Bracket Set X055	\$40.00	\$44.00
-----------------------------	---------	---------

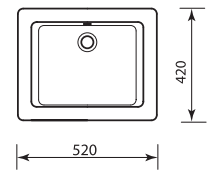

UTILITY SINK LARGE

Code
C5241.PW2

RRP (exc. GST)	RRP (inc. GST)
\$731.00	\$804.10

- Large rectangular, drop-in vitreous china laboratory sink
- Durable glaze finish
- Standard overflow
- Plastic O/Flow Plug & Waste 32/40mm included (Acid resistant)
- Nominal bowl capacity 29L

Optional (not included)

Undermount Bracket Set X055	\$40.00	\$44.00
-----------------------------	---------	---------

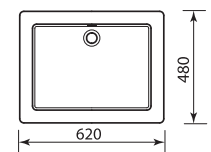

ANTI VANDAL SHOWER

ANTI VANDAL SHOWER

Code
JTV22CH

RRP (exc. GST)	RRP (inc. GST)
\$206.00	\$226.60

- Durable chromed brass construction
- Simple, secure fixing system
- WELS 3 Star, 8L/min. S15650

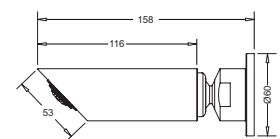

SCHOOL TOILET SUITES



PLAZA SCHOOL - WISE DELUXE

Code J2030.J2201W.G **RRP (exc. GST)** \$867.00 **RRP (inc. GST)** \$953.70

- Concealed outlet vitreous china S pan with vitreous china mid-level, bottom-entry cistern
- Suitable for domestic or commercial installations
- Includes a grey colour, Anti-Vandal seat
- Chrome finish buttons and flush-pipe
- Seat has no lid and incorporates lateral stabilizers
- A sturdy, reliable and durable product suitable for use in public spaces
- The toilet suite comes complete with XJ122B - Anti-Vandal Kit to prevent cistern lid removal without tools
- WELS 4 Star, 4.5/3L dual flush L06685

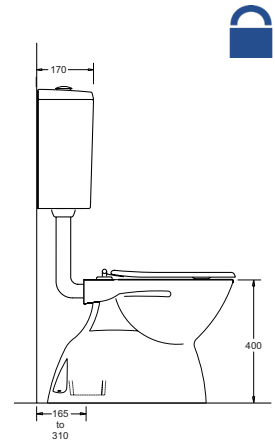

PLAZA SCHOOL - WISE AMBULANT DELUXE

Code J2031.J2201W.G **RRP (exc. GST)** \$970.00 **RRP (inc. GST)** \$1,067.00

- Concealed outlet vitreous china S pan with a VC cistern
- Suitable for use in domestic or commercial installations
- Raised height pan suitable for people with ambulant disabilities
- Chrome plated Flush pipe supplied have sufficient height and length to provide compliance with AS1428(2009) for ambulant use
- WELS 4 Star, 4.5/3L dual flush L06685
- Assist anti-vandal single flap seat supplied
- Anti-vandal cistern locking with chrome button

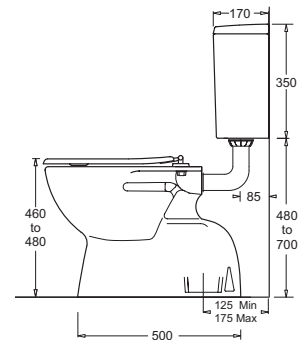

CHILDREN'S PRODUCTS



WINDSOR 410 COMPACT

Code	RRP (exc. GST)	RRP (inc. GST)
J3190.1.PW2	\$230.00	\$253.00

- Compact hand rinse wall basin
- Versatile basin suitable for a variety of installations
- Useful flat soap platform area
- Supplied with Plastic O / Flow Plug & Waste PW2
- Capacity 2.0L
- 1 Taphole

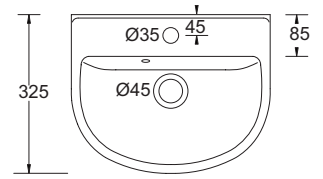

Shown with chrome pop up waste PW5 (not included)

EMILIA 450

Code	RRP (exc. GST)	RRP (inc. GST)
J3140.1.PW5	\$267.00	\$293.70

- Contemporary standard basin
- Small to mid size
- Wide soap platform area
- Matching pedestal available
- Supplied with PW1 Chrome O/Flow Plug & Waste 32/40mm

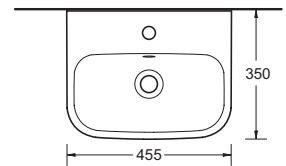

Optional Parts (not included)

40/32mm JS Bottle Trap BT1	\$234.00	\$257.40
----------------------------	----------	----------

EGG JUNIOR

Code	RRP (exc. GST)	RRP (inc. GST)
C01427.1.PW1	\$560.00	\$616.00

- Uniquely designed for children
- Can be wall or counter top mounted
- Unique curved bowl designed to reduce splashing and mess
- HYGIENE Glaze nano-technology prevents bacteria build up and improves cleaning time.
- Matching Egg Junior toilet suites available
- Supplied with PW1 Chrome O/Flow Plug & Waste 32/40mm
- 1 Taphole

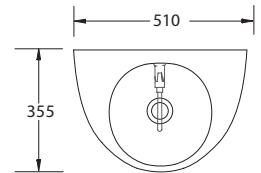

EGG JUNIOR

Code	RRP (exc. GST)	RRP (inc. GST)
White Cistern Lid		
C67977.C6262.11H.W	\$1,175.00	\$1,292.50
Blue Cistern Lid		
C67977.C6262.11H.B	\$1,175.00	\$1,292.50
Lemon Yellow Cistern Lid		
C67977.C6262.11H.L	\$1,175.00	\$1,292.50
Rose Apple (Pink) Cistern Lid		
C67977.C6262.11H.P	\$1,175.00	\$1,292.50
Kiwi Cistern Lid		
C67977.C6262.11H.K	\$1,175.00	\$1,292.50

- Child friendly, fun egg-shaped vitreous china close coupled toilet suite
- Coloured ceramic cistern lid in - Green, Yellow, Pink, Blue or White
- Low seat height suitable for children up to 12yrs
- Bowl finished in HYGIENE glaze for easy cleaning
- Includes a child safe soft close, quick release toilet seat
- Right hand water inlet
- Adjustable connector to achieve 90-160mm set out (X011H)
- Optional adjustable connector to achieve 160-200 mm set out (X011B)
- WELS 4 Star, 4.4/3L (3.3L average flush) L06606

Optional Parts (not included)

Connector 160 - 200mm Set out X011B	\$67.00	\$73.70
Anti Vandal Fitting XJ122A	\$63.00	\$69.30
Adjustable S connector for 140-200mm set out X011B	\$67.00	\$73.70

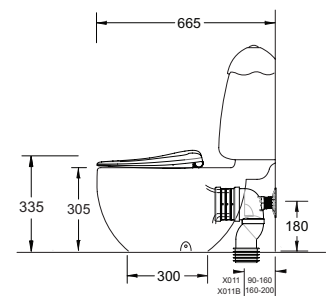





SPARE PARTS

JohnsonSuisse
Bathroom Solutions

COMPONENT FITTINGS

OUTLET VALVE

Code	RRP (exc. GST)	RRP (inc. GST)
XI200	\$43.00	\$47.30

- Fully adjustable dual flush valve with 38mm button and base
- Separate adjustment for both full and half flush

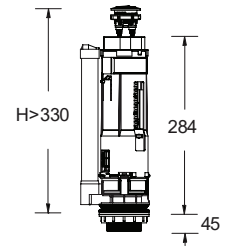

INLET VALVE - BOTTOM ENTRY

Code	RRP (exc. GST)	RRP (inc. GST)
XI210	\$25.00	\$27.50

- Suitable for suites with bottom water entry
- Water level can be easily
- Hose not supplied
- Reliable function

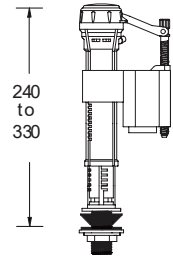

INLET VALVE - BACK ENTRY

Code	RRP (exc. GST)	RRP (inc. GST)
XI230	\$46.00	\$50.60

- Suitable for flush to wall type suites with back or bottom water entry
- Water level can be easily altered
- 400mm PVC coated stainless steel hose
- Reliable function
- To be used with Outlet Valve XI200

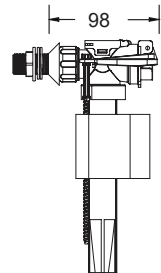

BACK TO BOTTOM CONVERSION KIT

Code	RRP (exc. GST)	RRP (inc. GST)
XJ108	\$83.00	\$91.30

- Back to bottom conversion kit

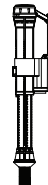

VITREOUS ENAMEL REPAIR KIT - WHITE

Code	RRP (exc. GST)	RRP (inc. GST)
J5020	\$151.00	\$166.10

- Easy to use
- Suitable for vitreous china and steel bath tubs, plus white goods and tiles



POLYMARBLE REPAIR KIT

Code	RRP (exc. GST)	RRP (inc. GST)
RKCW (WHITE)	\$79.00	\$86.90

- All Polymarble Bases, White
- Includes coloured gelcoat, catalyst, polish & applicator
- 2-3 months shelf life



VALVE SEAL SET

Code	RRP (exc. GST)	RRP (inc. GST)
XI221 (OUTLET)	\$10.00	\$11.00
XI223 (INLET)	\$10.00	\$11.00

- Replacement flush seal for outlet valves (XJ114, XJ110) plus shut-off diaphragm seal for inlet valves (XJ100, XJ104)



COMPONENT FITTINGS

PAN CONNECTOR

Code	RRP (exc. GST)	RRP (inc. GST)
X011H	\$60.00	\$66.00

- Provides variable S Trap set out to the suite

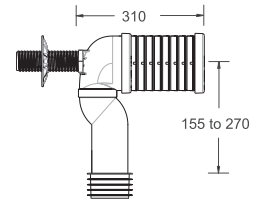

PAN CONNECTOR - LONG REACH

Code	RRP (exc. GST)	RRP (inc. GST)
X011B	\$67.00	\$73.70

- Can be used as an option to the standard connector in installations where a longer set out is required

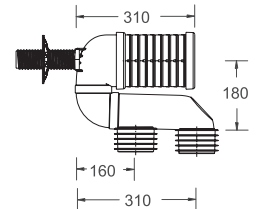

JOHNSONSUISSE SLIMLINE BOTTLE TRAP

Code	RRP (exc. GST)	RRP (inc. GST)
BT1	\$234.00	\$257.40
BT1B	\$272.00	\$299.20

- 32/40mm adapter supplied
- Long horizontal connection adjustment
- Compatible with all wall basins

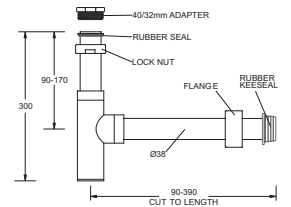

JOHNSONSUISSE BOTTLE TRAP

Code	RRP (exc. GST)	RRP (inc. GST)
BT2 Chrome	\$151.00	\$166.10
BT2EMB Matte Black	\$188.00	\$206.80
BT2EGM Gun Metal	\$219.00	\$240.90
BT2PBN PVD Brushed Nickel	\$219.00	\$240.90
BT2PBB PVD Brushed Brass	\$219.00	\$240.90

Compatible with

- Compatible with all our Plug & Wastes except for PW3 and PW8
- Fits 32mm waste outlets

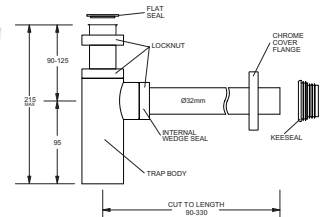

JOHNSONSUISSE SHOWER DUAL CHECK VALVE

Code	RRP (exc. GST)	RRP (inc. GST)
XJTV400CH	\$36.00	\$39.60
XJTV400EMB	\$55.00	\$60.50
XJTV400EGM	\$66.00	\$68.20

- Compatible with all Venezia Showers and Living/Life Assist 3 Function Rail Showers



PLUG & WASTE 32/40MM WITH OVERFLOW - CHROME

Code	RRP (exc. GST)	RRP (inc. GST)
PW1	\$33.00	\$36.30

- All Basins



PLUG & WASTE 32/40MM WITH OVERFLOW - PLASTIC

Code	RRP (exc. GST)	RRP (inc. GST)
PW2	\$26.00	\$28.60

- All Basins



COMPONENT FITTINGS

POP UP WASTE 40MM WITHOUT OVERFLOW

Code	RRP (exc. GST)	RRP (inc. GST)
PW3	\$66.00	\$72.60

- Esti baths



PLUG & WASTE 2-PIECE 50MM PLASTIC

Code	RRP (exc. GST)	RRP (inc. GST)
PW4	\$33.00	\$36.30



POP UP WASTE 32MM WITH OVERFLOW

Code	RRP (exc. GST)	RRP (inc. GST)
PW5 - Chrome	\$34.00	\$37.40
PW5EMB - Matte Black	\$62.00	\$68.20
PW5EGM - Gun Metal	\$67.00	\$73.70
PW5PBN - PVD Brushed Nickel	\$67.00	\$73.70
PW5PBB - PVD Brushed Brass	\$67.00	\$73.70

- All Johnson Suisse basins with Overflow



POP UP WASTE 32MM WITHOUT OVERFLOW

Code	RRP (exc. GST)	RRP (inc. GST)
PW6 - Chrome	\$34.00	\$37.40
PW6EMB - Matte Black	\$62.00	\$68.20
PW6EGM - Gun Metal	\$67.00	\$73.70
PW6PBN - PVD Brushed Nickel	\$67.00	\$73.70
PW6PBB - PVD Brushed Brass	\$67.00	\$73.70

- All Johnson Suisse basins without Overflow

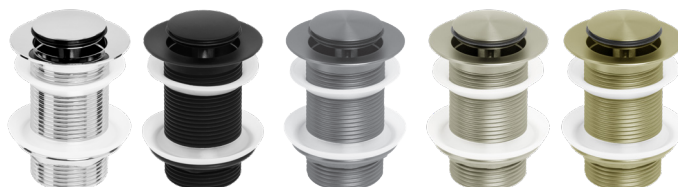

PLUG & WASTE POP-DOWN 32MM OVERFLOW

Code	RRP (exc. GST)	RRP (inc. GST)
PW7 - Chrome	\$113.00	\$124.30
PW7B - Matte Black	\$201.00	\$221.10

- Suitable for basins designed for 32mm or 40mm waste fittings
- Durable brass construction with Chrome EP finish
- Adjustable length to suit a wide range of basin models



TOILET SEAT HINGE COVER WHITE (PAIR)

Code	RRP (exc. GST)	RRP (inc. GST)
XJ191 - 55mm	\$44.00	\$48.40
XJ192 - 60mm	\$51.00	\$56.10

- 55mm suitable for: JTTG705.712, JTTG711.715, JTTG301.JTTG302, JTTE405, JTTE406.105, JTTE405.JTTE406.110
- 60mm suitable for: JTTV611.315, JTTV711.315, JTTV331.JTTV333.315, JTTV321.JTTV312.311



BATH PLUG & WASTE 40MM POP-DOWN INCLUDING CONNECTOR

Code	RRP (exc. GST)	RRP (inc. GST)
PW8 - Chrome	\$117.00	\$128.70
PW8B - Matte Black	\$192.00	\$211.20
PW8PGM - Gunmetal	\$192.00	\$211.20
PW8PBN - Brushed Nickel	\$192.00	\$211.20
PW8PBB - Brushed Brass	\$192.00	\$211.20



POP-UP WASTE DOME 40MM WITH OVERFLOW

Code	RRP (exc. GST)	RRP (inc. GST)
PW10	\$71.82	\$79.00



SPARE PARTS

ANTI VANDAL FITTINGS

Code	RRP (exc. GST)	RRP (inc. GST)
XJ122A (38MM)	\$63.00	\$69.30
XJ122B (48MM)	\$66.00	\$72.60

- Cisterns with 38mm and 48mm flush buttons.
- See individual toilet suite page for compatibility

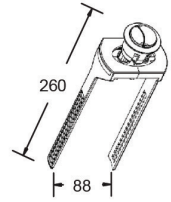

FLUSH BUTTON 48MM

Code	RRP (exc. GST)	RRP (inc. GST)
XJ207 Chrome	\$44.00	\$48.40
XJ207MB Matte Black	\$44.00	\$48.40
XJ207GM Gun Metal	\$44.00	\$48.40
XJ207BN Brushed Nickel	\$44.00	\$48.40
XJ207BB Brushed Brass	\$44.00	\$48.40



Not Compatible with:

- Emilia XTRA and Venezia Ambulant

38MM BUTTON CHROME

Code	RRP (exc. GST)	RRP (inc. GST)
XJ147	\$36.00	\$39.60

Compatible with

- Cotto Cisterns



R&T - 38MM BUTTON CHROME (HALF/HALF)

Code	RRP (exc. GST)	RRP (inc. GST)
XJ140 Chrome	\$35.00	\$38.50
XJ140B Black	\$42.00	\$46.20

Compatible with

- Johnson Suisse
- Imex



R&T - RECTANGLE BUTTON CHROME (64 X 35MM)

Code	RRP (exc. GST)	RRP (inc. GST)
XJ145	\$35.00	\$38.50

Compatible with

- Plastic Cisterns: G1200, G1203



R&T - 48MM BUTTON CHROME

Code	RRP (exc. GST)	RRP (inc. GST)
XJ144	\$47.00	\$51.70

Compatible with

- Plastic Cisterns: G1200, G1203



SEAT HINGE BOLT SET FOR COTTAGE

Code	RRP (exc. GST)	RRP (inc. GST)
X019	\$16.00	\$17.60

Compatible with

- Seat G1027



SEAT HINGE BOLT SET FOR MODE

Code	RRP (exc. GST)	RRP (inc. GST)
X025A	\$16.00	\$17.60

Compatible with

- Seat G1028A



SPARE PARTS

SEAT PIVOT PINS FOR MODE

Code	RRP (exc. GST)	RRP (inc. GST)
X025B	\$16.00	\$17.60

Compatible with

- Seat G1028



HINGE BLOCK CHROME TOP FIXED FOR SOFT CLOSE SEAT

Code	RRP (exc. GST)	RRP (inc. GST)
XC9892	\$114.00	\$125.40

Compatible with

- Seat C90801



HINGE ASSEMBLY TOP FIXED FOR STANDARD SEAT

Code	RRP (exc. GST)	RRP (inc. GST)
XC9895	\$89.00	\$97.90

Compatible with

- Seat C90802



CLIP-ON MODE LINK

Code	RRP (exc. GST)	RRP (inc. GST)
(Plastic Tank) X0255	\$24.00	\$26.40

Compatible with

- Seat G1028
(Suitable for plastic cisterns)



R&T LINK PIECE

Code	RRP (exc. GST)	RRP (inc. GST)
XR906	\$24.00	\$26.40

Compatible with

- RB1038SC



F300 OUTLET

Code	RRP (exc. GST)	RRP (inc. GST)
X001B	\$72.00	\$79.20

Compatible with

- Cottage
- Basix
- Mode
- Reno
- Universal Replacement

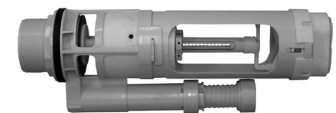

R&T COMPLETE VALVE

Code	RRP (exc. GST)	RRP (inc. GST)
XJ112	\$74.00	\$81.40

Compatible with

- Older Johnson Suisse Suites with Large Button

Cistern Collar supplied



SPARE PARTS

R&T BLANKING BUNG

Code	RRP (exc. GST)	RRP (inc. GST)
XJ160	\$12.00	\$13.20

Compatible with

- Modena
- Lucerne
- Civic Plus
- Plaza Plus
- Charm II



CISTERN TO PAN ATTACHMENT BOLTS & WASHERS

Code	RRP (exc. GST)	RRP (inc. GST)
XJ193	\$63.00	\$69.30

Compatible with

- Life
- Heart
- Mirage
- Melise
- Cato



CAPNUT L - LOW LEVEL TYPE

Code	RRP (exc. GST)	RRP (inc. GST)
X013A	\$24.00	\$26.40

Compatible with

- Wall mounted Plastic Link Suites



CAPNUT - MID LEVEL TYPE

Code	RRP (exc. GST)	RRP (inc. GST)
X023	\$24.00	\$26.40

Compatible with

- Mid Level Plastic Cisterns



WATER CONNECTOR 1/2"

Code	RRP (exc. GST)	RRP (inc. GST)
XJ203	\$37.00	\$40.70

Compatible with

- FTW Suites bottom water inlet



HOSE CONNECTOR

Code	RRP (exc. GST)	RRP (inc. GST)
XJ162	\$18.00	\$19.80

Compatible with

- Life
- Heart
- Milano FTW
- Melise
- Cato



FLUSH PIPE TO PAN EXTERNAL FLUSH CONE (110MM)

Code	RRP (exc. GST)	RRP (inc. GST)
X016A	\$14.00	\$15.40

Compatible with

- Pans with Water Inlet Flush Horn

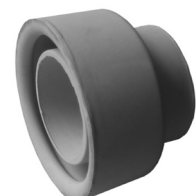

SPARE PARTS

FLOOR BRACKET

Code	RRP (exc. GST)	RRP (inc. GST)
XTWP10	\$66.00	\$72.60

Compatible with

- Space Solution
- Tetragon
- Proteus II
- Living
- Egg Jnr



PAN FLOOR BRACKET

Code	RRP (exc. GST)	RRP (inc. GST)
XJ200	\$36.00	\$39.60

Compatible with

- Cottage One Piece
- Modena
- Life
- Heart
- Mirage FTW
- Melise
- Cato

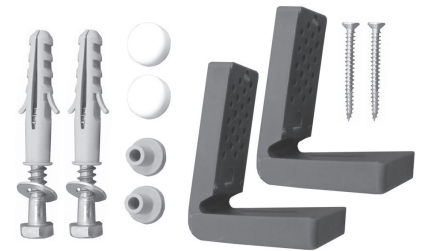

SMC WASTE & DOME COVER WHITE

Code	RRP (exc. GST)	RRP (inc. GST)
ODUBWH.AP (Waste only for SMC, White)	\$30.00	\$33.00
OUDOCW (SMC & EVO Dome Cover White)	\$42.00	\$46.20

Compatible with

- SMC Bases



TILE TRAY WASTE DRAIN AND COVER CHROME

Code	RRP (exc. GST)	RRP (inc. GST)
OUTTCHS	\$100.00	\$110.00

Compatible with

- 995x995 Tile Trays



ELECTRONIC URINAL VALVE COVER PLATE

Code	RRP (exc. GST)	RRP (inc. GST)
J6209	\$321.00	\$353.10

Compatible with

- Schell HF electronic valve for urinal

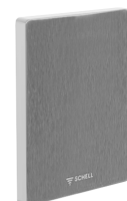

For most up to date Spare Part Lists, go to www.johnsonsuiss.com.au/spareparts

JohnsonSuisse

Bathroom Solutions

2/97 Banksia Street, Botany NSW 2019 | T 1300 717 717 | F 1300 746 480 | www.johnsonsuisse.com.au

BATHROOM PRODUCTS AUSTRALIA PTY LTD ABN 87 079 297 617

VIC Showroom: 31 Koornang Road, Scoresby VIC 3179 Australia | T 1300 717 717 | F 1300 746 480

SYDNEY Showroom : 2/97 Banksia St. Botany Sydney NSW 2019 Australia | T 1300 717 717 | F 1300 746 480

Material and design specifications subject to change without notice.

Product colour reproduction is as near to actual product colour as production methods allow.

This brochure relates to Australian products only and some product, design or specifications may differ in other countries.